

# MultiCard – A Printing System for Terminals, Wires and Devices

Product Information



# MultiCard

---

<b>The MultiCard concept</b>	4
Description of material	6
Tests and test procedures	7
Standards and regulations	8

---

<b>Terminal markers</b>	10
-------------------------	----

---

<b>Wire and cable markers</b>	24
-------------------------------	----

---

<b>Device markers</b>	36
-----------------------	----

---

<b>Printers</b>	41
-----------------	----

---

<b>Software M-Print® PRO</b>	45
------------------------------	----

---

<b>Cable ties</b>	46
-------------------	----

---

## A Printing System for Terminals, Wires and Devices

Weidmüller's MultiCard concept is a standardised, innovative printing system with more than 100 marker variants for terminal connectors, wires and cables as well as devices and installations from a wide range of manufacturers.

The MultiCard marking system consists of a harmonised combination of:

### MultiCard software

Using the software M-Print PRO, you can plan individual printing of single MultiCard strips. Independent of the sequences of the letters, it is possible to prepare markings for whole blocks of terminals in advance. You only need to create markers that you currently need – and in the sequence that the assembly dictates. Thus, you are able to prevent time-consuming puzzling games during installation procedures.

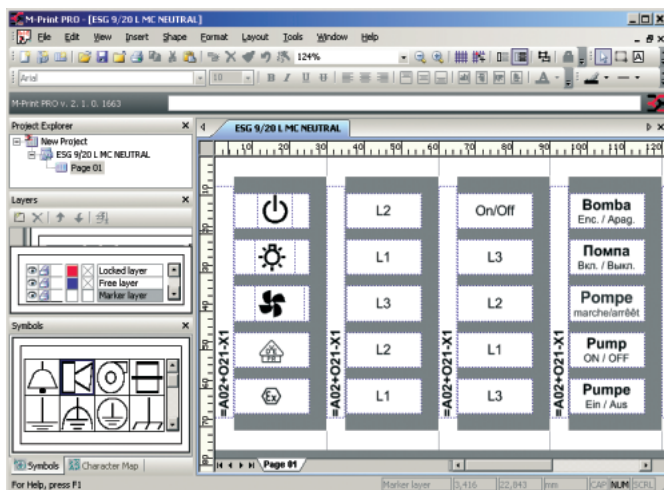

Versatile and rapid creation of individual printings through utilising the MultiCard system make it possible for you to save time and costs when marking your electrical installation.

### MultiCard printers

Weidmüller specially developed the printers **PrintJet** and **SpeedMarking Laser** for the MultiCard concept. No compromises were made with regard to printing quality, printing speed or operating comfort. All of the advantages of modern-day printing technology have been optimised to suit the MultiCard system.



### Your advantages

- Individual planning of markings
- No need to stock pre-printed markers

### Your advantages

- Highest printing quality
- Fastest printing speed

## MultiCard markers

The uniform format of the strips for individual markers forms the core of Weidmüller's MultiCard concept. Connected in strips, individual tags can easily be separated thanks to knockout perforations or mounted as a complete strip in a single action to save time.



## Everything from a single source

Utilising Weidmüller's MultiCard concept allows you to create practically all markings for terminal connectors, cables and devices of various makes with a single system. The perfectly harmonised combination of software, printer and markers guarantees the best possible printing quality and rapid results. Making use of this combination from a single-source supplier, allows you to cut back your logistics and reduce your storage requirements.

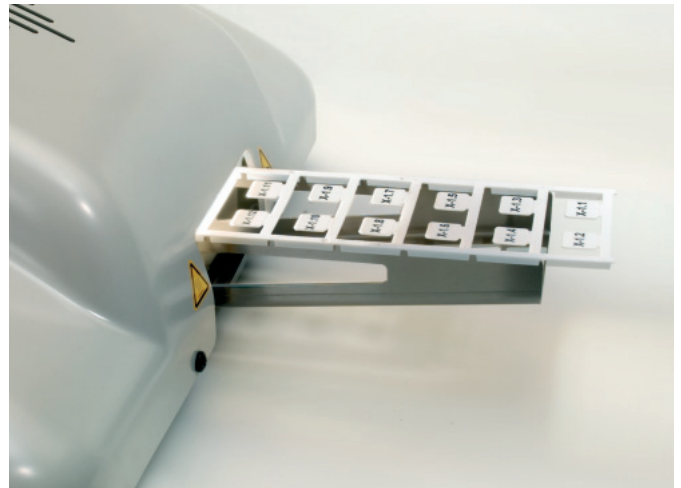

### Your advantages

- Variations to suit all your marking needs
- Mount as individual tag or together in strips
- Reduce mounting times and effort
- Excellent material characteristics
- No scraping tags together during mounting

### Your advantages

- Individual components – optimised to harmonise
- One printing system for all applications
- One supplier
- Cut back logistics and reduce storage requirements

## Description of material

Material	Description
<b>Polyamide</b>	<p>Due to its good electrical and mechanical characteristics, its versatility and lack of susceptibility to fracture, polyamide (PA) is one of the most frequently used synthetic materials in technical applications. Thanks to its chemical structure, PA is also flame resistant without the addition of flame-retarding substances.</p> <p><b>Temperature range:</b> <b>-40 °C to +100 °C</b></p>
<b>PVC</b>	<p>Soft PVC is manufactured from polyvinyl chloride and plasticisers as well as additives such as stabilisers and slip agents. It is generally transparent and can be dyed in any colour. PVC is resistant to corrosive salt solutions and most acids and alkaline solutions. Due to its chemical structure, rough PVC is non-aging; it is not affected by oxygen and ozone.</p> <p><b>Temperature range:</b> <b>-30 °C to +80 °C</b></p>
<b>Polypropylene</b>	<p>Polypropylene (PP) belongs to the polyolefine group of materials. Good chemical resistance and electrical characteristics are distinguishing features of this semi-crystalline plastic. Strongly oxidising chemicals can attack PP.</p> <p><b>Temperature range:</b> <b>-40 °C to +80 °C</b></p>
<b>POM</b>	<p>Polyacetal is also known as polyoxymethylene, abbreviated to POM. Its distinguishing characteristics include a high-degree of tensile strength, hardness and stiffness across a wide temperature range.</p> <p><b>Temperature range:</b> <b>-60 °C to +110 °C</b></p>

# Weidmüller tests and test procedures

Tests	Test conditions/requirements
<b>Materials test</b>	Flammability in accordance with UL94-V0 Shore A hardness test A – ISO 868 Surface resistance – DIN IEC 60093
<b>Ageing</b>	Due to its chemical structure, PVC is extremely non-aging; it is not affected by oxygen and ozone.
<b>Function test of PTFE and PVC wire insulation</b>	Suitability of markers for installation at -10 °C to +40 °C. Correct attachment test of the respective marker size for the smallest to the largest wire diameter Test for symmetry of the marker on the wire
<b>Vibration resistance on carrier</b>	Vibration test, industry, in accordance with: DIN EN 60068-2-6, sinusoidal (3 axes, 10 cycles per axis, acceleration 5g, frequency 10-500 Hz, sweep rate 1 octave/minute) Weidmüller test specifications – LPV 2272
<b>Wipe resistance</b>	Resistance of the print against the affects of hand perspiration, machine oil, water and ethanol. A slight alteration is permissible, however, clear identification (legibility) must be guaranteed. In the case of prints subject to VDE 0611 P 4 (rating plate details), the wipe resistance against water and mineral spirits is to be tested for a period of 15 minutes. Standards: DIN VDE 0611-4 / Pt. 3.1.3 DIN EN 60947-1/ Pt. 5.1 DIN EN 60742, CEI 16-7 Weidmüller test specifications – LPV 2166
<b>Scratch resistance</b>	No scratches must be visible on the base or the carrier following the finger-nail test. A slight alteration is permissible, however, clear identification must be guaranteed. Weidmüller test specifications – LPV 2165
<b>UV light resistance</b>	The function must be guaranteed. The print or colour of the product must be clearly recognisable. Standard: DIN EN ISO 4892-2; Weidmüller test specifications – LPV 2216
<b>Chemical resistance of the print</b>	Weidmüller test specifications – LPV 2167

# Standards and regulations for markings

## Safety, ease of maintenance and gain

Markers are not an end to themselves, but are a basic requirement for rapid and reliable maintenance as well as successful troubleshooting procedures. This is a particularly important under the aspect of product reliability legislation, because when damage occurs it is possible to quickly trace the possible cause. In addition, clear and unambiguous identification of electrical equipment and installations is binding for all. Standards requiring adherence are: DIN EN 60204-1 (VDE 0113 Part 1):1998-11 [1, 2] Electrical equipment of machines; Safety group standard, Type B1 in compliance with CEN classification) and DIN EN 61082-1:1995-05 [3] previously (DIN 40719-2 [4]). A further requirement: markings should be made of non-metallic materials and be resistant to oils, water, cleaning agents based on oils as well as UV radiation.

## 'Structured marking'

The standard DIN EN 61082-1 (VDE 0113 Part 1:1998-11 [1]) dictates that markings consist of four blocks for clear and unambiguous identification markings. If the circuit diagram lacks space, blocks not absolutely required for identification purposes can be left out. In this case, it is possible to alter the sequence of the blocks.

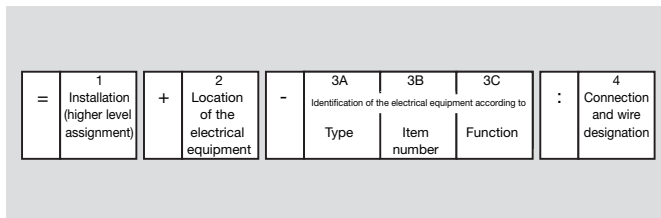

## Identification block 1: 'Installation'

Block 1 with the sign '=' denotes higher level assignment. This for marking the entire installation or system. The block is divided up into five sections, which generally contain two positions. One means of differentiation is the sequence of letters and digits. There are a total of max. ten positions possible. The marking begins from the left with the largest functional unit and ends on the right with the smallest.

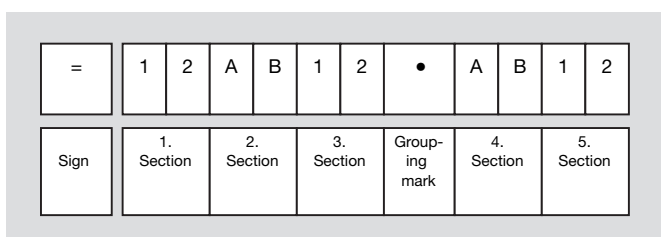

## Identification block 2: 'Location of the electrical equipment'

Block 2 with the sign '+' allows for rapid localisation of the electrical equipment in larger installations. As a rule, the marking consists of letters or digits that describe the co-ordinates; they are generally divided up into six sections each with two positions (in section six there are as many as eight positions). In total, a max. of 18 positions are possible. The place of installation is to the left of the group mark, the position of installation is to the right.

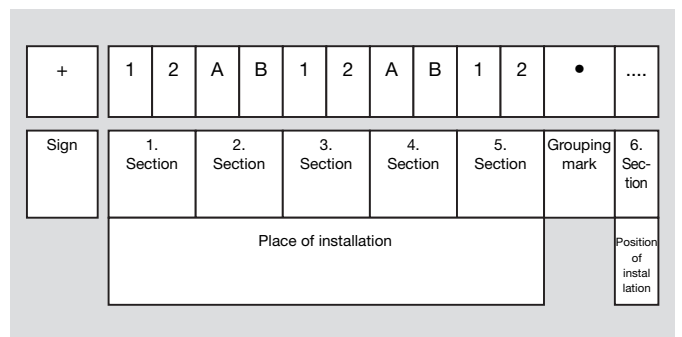

For practical purposes, the installation and location markings can be made using the 'ClipCard' device markers. The system consists of an identification system in MultiCard format as well as the card holder in an open design. The program is rounded off with a tag rail including transparent sleeves. The card holder has been designed to allow a wide variety of attachment options. The identification cards are supplied without markings. Of course, individual printing options are available.

## Identification block 3: 'Type and function'

All electrical equipment is given a type identification by the manufacturer. In addition, identification block 3 with the '-' sign is a distinguishing feature providing information about the type and function of the electrical equipment. Block 3A is labelled using letters. The item number 3B provides information to help distinguish between items of equipment, should there be multiples of the same type of equipment in service or the blocks 3A and 3C are missing. Consecutive numbers can be used. Finally, it is possible to identify the function of the electrical equipment with 3C.

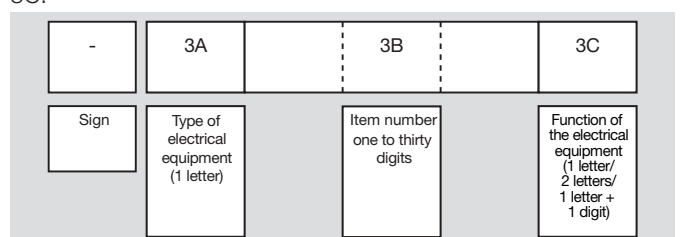



**Block 3: 'Marking of electrical equipment'**

Type, item number and function are differentiated. Electrical equipment identified as devices are, for example, indicator lights, contactor relays, miniature circuit-breaker, power supplies, relay couplers, terminal blocks, interface units, starting circuit breakers and all control devices.

**Examples: 'Electrical equipment block 3A'**

Type of device	Classification letter	Example
Switch for heavy current	Q	Starting circuit breaker, disconnecter, circuit-breaker
Contactor	K	Power contactor, contactor relay, relay coupler, timing relay
Protective equipment	F	Fusible links, miniature circuit-breaker, overvoltage protection, monitoring modules
Motors	M	Three-phase motor, DC motor
Transformer	U	AD converter, modules for converting an electrical quantity into a different quantity, for example, V – I, I – f switching modules
Connection elements	X	Terminal blocks, connectors, terminal boards, socket outlets, isolating plugs

**Identification block 4: 'Connection and wire designation'**

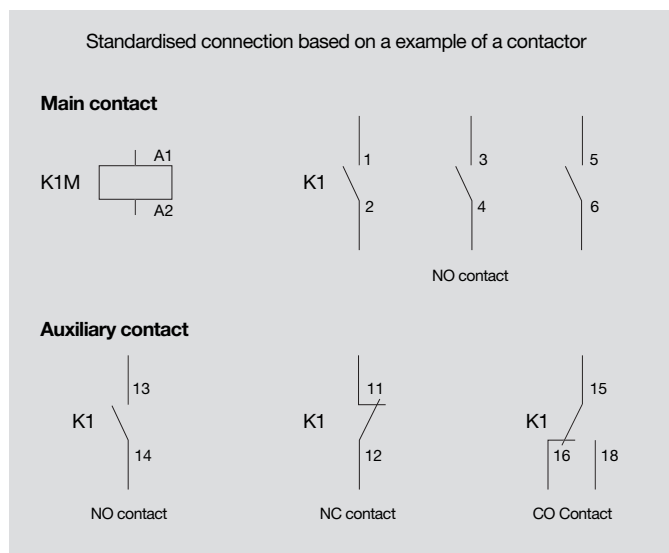

Block 4 with sign ':' contains the connection and wire designation of the electrical equipment. These are laid down in standards. The companies supplying the equipment mark their devices during the manufacturing process with the corresponding designation. Where no agreement has been reached with regard to designation or the designation is not customary in practical applications, the designation of the connection is numbered sequentially.

**Direction designation (external – internal)**

As well as providing a clear overview of the designations of the connection points, internal and external direction designations facilitate rapid troubleshooting tasks. Wires connected to the terminal blocks are the most suitable for direction designations. Here the wire and cable markers show their worth with simple fixation onto the wire wire.

External direction designation		Terminal strip			Internal connection strip	
Designation	Connection	Connection	Symbol	Connection	Designation	Connection
<b>Example variant 1</b>		<b>= K3 + S1 - X1</b>				
= K3 + S6 - X12 : 4	1	1	⊣—	1	= K3 + S1 - F1 : 96	
<b>Example variant 2</b>		<b>= K3 + S1 - X1</b>				
= K3 + S6 - X12 : 4	1	1	⊣—	1	= K3 + S1 - F1 : 96	

**Literature**

- [1] DIN EN 60204-1 (VDE 0113 Part 1):1998-11 Safety of machinery - Electrical equipment of machines - Part1: General requirements. Berlin – Offenbach: VDE VERLAG (publishers) – available from www.vde-verlag.de.
- [2] IEC 60204-1:2000-05 Safety of machinery – Electrical equipment of machines – Part 1: General requirements. Genf/Switzerland: Bureau Central de la Commission Electrotechnique Internationale – available from www.iec-normen.de.
- [3] DIN EN 61082-1:1995-05 Preparation of documents used in electrotechnology – Part 1: General requirements. Berlin: Beuth – available from www.beuth.de.
- [4] Z DIN 40719-2:1973-06 circuit documentation

# Markers for terminal connectors and plug-in connectors

## Dekafix

Dekafix (DEK) markers are universal markers for all terminals and plug-in connectors as well as electronics modules. Including a wide range of ready-for-use prints, the system is particularly suitable for short sequences of digits.

Rapid strip mounting allows the markers to be clipped on in a single action. Available in five widths, the high-contrast print is easily legible.

- Large selection of ready-printed markers
- Rapid mounting in strips
- Terminal markers suitable for all Weidmüller terminal connectors

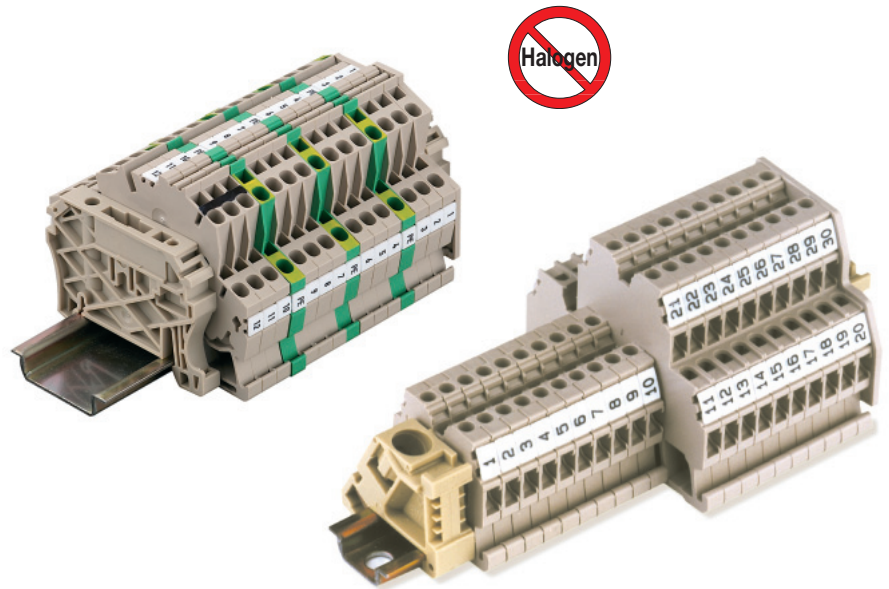

### Technical data

Colour	Available in all colours of the international colour code; for MC on request ● brown, ● red, ● orange, ● yellow, ● green, ● blue, ● violet, ● grey, ○ white
Notes on mounting	Mount in strips when marker grid (width) corresponds to the grid of the terminal blocks. For example, DEK 5 mm pitch for terminals with 5-mm terminal grid; such as the WDU 2,5. Mount individual tags when the terminal grid is larger than the marker grid. For example, DEK 6.5 mount individually on WDU 6. Weidmüller markers with 5-mm grid (width) suitable for all widths of terminals.
Possible printing systems	Plotter, SMark-Laser, PrintJet, MC-Mobilo

### Ordering information

#### MultiCard

Minimum order quantity	1 Qty.
Package	Cardboard box

### Number of characters when using plotter font

Pin size	0.18	0.25	0.35	0.18	0.25	0.35
Typeface (pt)	10	10	10	4	5	6
Tag width (mm) <b>3.5</b>	2	2	2	5	4	3
Tag width (mm) <b>5</b>	2	2	2	5	4	3
Tag width (mm) <b>6</b>	2	2	2	6	5	4
Tag width (mm) <b>6.5</b>	3	3	3	7	5	4
Tag width (mm) <b>8</b>	4	4	4	9	7	6

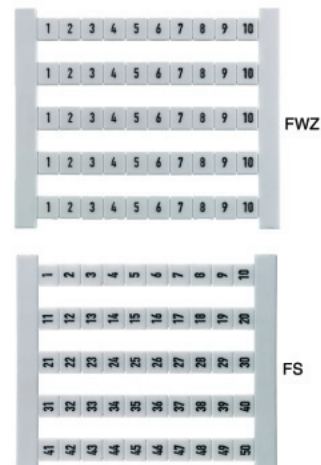
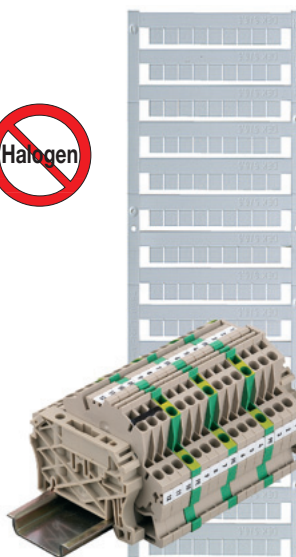

**Technical data**

Material	Polyamide
Flammability class to UL94	V2
Temperature range °C	-40...100

**Terminal width 3.5 mm DEK**

Type	Length [mm]	Qty.	Order No.
<b>Neutral white</b>			
DEK 5/3,5 MC	5	500	1755270000
<b>Custom print white</b>			
DEK 5/3,5 MC	5	100	1767730000

**Terminal width 6 mm DEK**

Type	Length [mm]	Qty.	Order No.
<b>Neutral white</b>			
DEK 5/6 MC	5	1000	1609820000
<b>Custom print white</b>			
DEK 5/6 MC	5	200	1609830000

**Terminal width 7.5 mm DEK**

Type	Length [mm]	Qty.	Order No.
<b>Neutral white</b>			
DEK 5/7,5 MC	5	320	1720620000
<b>Custom print white</b>			
DEK 5/7,5 MC	5	320	1770490000

**Terminal width 5 mm DEK**

Type	Length [mm]	Qty.	Order No.
<b>Neutral white</b>			
DEK 5/5 MC	5	1000	1609801044
DEK 5/5 Plus MC	5	1000	1854490000
<b>Custom print white</b>			
DEK 5/5 MC	5	200	1609810000
DEK 5/5 Plus	5	200	1854500000

**Terminal width 6.5 mm DEK**

Type	Length [mm]	Qty.	Order No.
<b>Neutral white</b>			
DEK 5/6,5 MC	5	900	1609840000
<b>Custom print white</b>			
DEK 5/6,5 MC	5	180	1609850000

**Terminal width 8 mm DEK**

Type	Length [mm]	Qty.	Order No.
<b>Neutral white</b>			
DEK 5/8 MC	5	800	1856740000
<b>Custom print white</b>			
DEK 5/8 MC	5	500	1856750000

## Terminal markers

### WS/ZS

WS markers have been optimised for W-Series terminal connectors. Thanks to their system compatibility, WS tags can be used for products from the I-Series and the Z-Series. The large marking surface is suitable for long sequences of characters as well as several lines of information.

WS markers are particularly suitable for marking lengthy, individually created sequences of characters. The proven MultiCard format means it is possible to print with any of the printers Laser, PrintJet, Plotter or MC-Mobilo.

- Mount in strips or individually
- Markers available in the proven MultiCard format

### ZS

ZS markers – available in the proven MultiCard format – have been specially developed for the Z-Series. They offer a large marking surface. The hinged mechanism even allows access to cross-connectors without having to dismount the markers first. Snap-on attachment of individual tags in strips guarantees rapid mounting. The individual tags can easily be separated from the strips.

- Hinged marker surface
- Mount in strips or individually
- Markers available in the proven MultiCard format

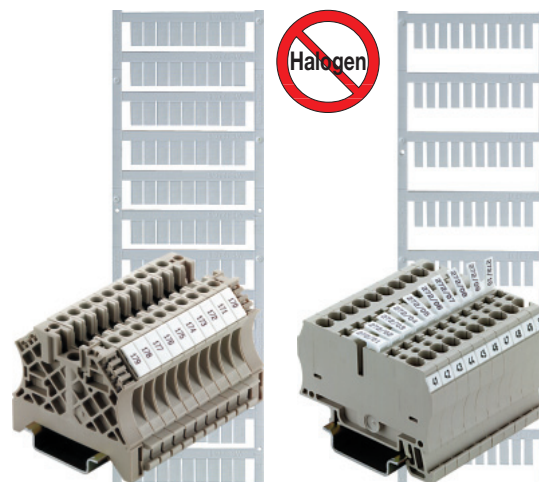

### Technical data

#### WS

Colour	Available in all colours of the international colour code; for MC on request ● brown, ● red, ● orange, ● yellow, ● green, ● blue, ● violet, ● grey, ○ white
Notes on mounting	Mount in strips when marker grid (width) corresponds to the grid of the terminal blocks. For example, WS 10/6 = 6-mm terminal grid For terminals with 6-mm terminal grid such as WDU 4 Mount individual tags when the terminal grid is larger than the marker grid. For example, WS 12/6.5 mount individually on WDU 6 Weidmüller markers with 5-mm grid (width) suitable for all widths of terminals.

#### ZS

Colour	white
Notes on mounting	Height x width (terminal grid) Example: ZS 10/5 10 mm in height, 5 mm width = 5 mm grid
Possible printing systems	Plotter, SMark-Laser, PrintJet, MC-Mobilo

### Ordering information

#### WS and ZS MultiCard

Definition of quantity	1 strip
Minimum order quantity	1 Qty.

#### WS card

WS .../5 only	
Definition of quantity	1 card = 30 items
Minimum order quantity	1 Qty.

### Number of characters when using plotter font

#### WS

Pin size	0.18	0.25	0.35	0.18	0.25	0.35
Typeface (pt)	10	10	10	4	5	6
Tag width (mm)	<b>8</b>	4	4	4	9	7
Tag width (mm)	<b>10</b>	4	4	4	11	9
Tag width (mm)	<b>12</b>	5	5	5	13	11
Tag width (mm)	<b>15</b>	7	7	7	17	14

#### ZS

Pin size	0.18	0.25	0.35	0.18	0.25	0.35
Typeface (pt)	10	10	10	4	5	6
Tag width (mm)	<b>10</b>	4	4	4	11	9
Tag width (mm)	<b>12</b>	5	5	5	13	11
Tag width (mm)	<b>15</b>	7	7	7	17	14
Carrier system (mm)	Z-Series, W-Series, SAK Series					

### Ordering data

Terminal width ≥ 5 mm			
Type	Print	Qty.	Order No.
<b>WS 8...15/5</b>			
WS 12/5	FSZ 1 - 10	300	1773430001
WS 12/5	FSZ 11 - 20	300	1773430011
WS 12/5	FSZ 21 - 30	300	1773430021
WS 12/5	FSZ 31 - 40	300	1773430031
WS 12/5	FSZ 41 - 50	300	1773430041
<b>WS 12/5</b>			
WS 12/5	FWZ 1 - 10	300	1773330001
WS 12/5	FWZ 11 - 20	300	1773330011
WS 12/5	FWZ 21 - 30	300	1773330021
WS 12/5	FWZ 31 - 40	300	1773330031
WS 12/5	FWZ 41 - 50	300	1773330041

### Ordering data WS cards – standard print

### Ordering data

Terminal width ≥ 5 mm			
Type		Qty.	Order No.
<b>WS 8...15/5</b>			
WS 8/5 card		300	1773360000
WS 10/5 card		300	1773370000
WS 12/5 card		300	1773380000
<b>Colour variations on request</b>			

### WS card – Custom print to specifications

## Technical data

Material	Polyamide
Flammability class to UL94	V2
Temperature range °C	-40...100

WS 10/5 Middle and 10/6 Middle are equipped with a centred foot.

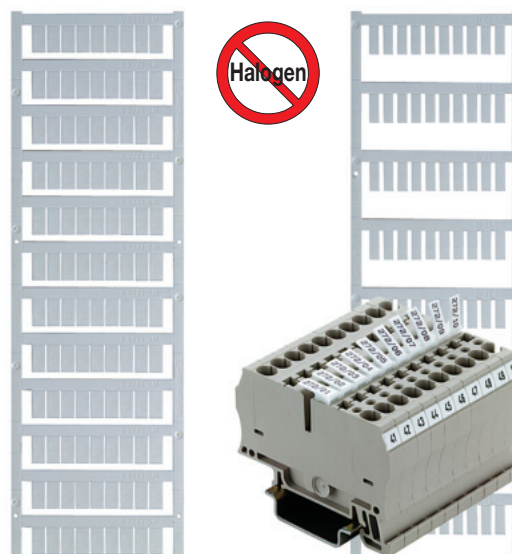

### Terminal width 3.5 mm WS/ZS

Type	Length [mm]	Qty.	Order No.
<b>Neutral white</b>			
WS 12/3,5 MC	12	600	1778270000
<b>Custom print white</b>			
WS 12/3,5 MC	12	120	1778280000

### Terminal width 6 mm WS/ZS

Type	Length [mm]	Qty.	Order No.
<b>Neutral white</b>			
WS 10/6 MC	10	600	1828450000
WS 10/6 MC Middle	10	600	1818400000
WS 12/6 MC	12	600	1609900000
<b>Custom print white</b>			
WS 10/6 MC	10	120	1828460000
WS 10/6 MC Middle	10	120	1818410000
WS 12/6 MC	12	120	1609910000

### Terminal width 5 mm WS/ZS

Type	Length [mm]	Qty.	Order No.
<b>Neutral white</b>			
ZS 10/5 MC	10	480	1610000000
ZS 15/5 MC	15	480	1646630000
<b>Custom print white</b>			
ZS 10/5 MC	10	96	1610010000
ZS 15/5 MC	15	96	1646640000

### Terminal width 5 mm WS/ZS

Type	Length [mm]	Qty.	Order No.
<b>Neutral white</b>			
WS 8/5 MC	8	720	1640740000
WS 10/5 MC	10	720	1635000000
WS 10/5 MC Middle	10	720	1792000000
WS 12/5 MC	12	720	1609860000
WS 14/5 MC	14	480	1768090000
WS 15/5 MC	15	480	1609880000
<b>Custom print white</b>			
WS 8/5 MC	8	144	1640750000
WS 10/5 MC	10	144	1635010000
WS 10/5 MC Middle	10	144	1792010000
WS 12/5 MC	12	144	1609870000
WS 15/5 MC	15	96	1609890000

### Terminal width 6.5 mm WS/ZS

Type	Length [mm]	Qty.	Order No.
<b>Neutral white</b>			
WS 12/6,5 MC	12	540	1609920000
<b>Custom print white</b>			
WS 12/6,5 MC	12	108	1609930000

### Terminal width 6 mm WS/ZS

Type	Length [mm]	Qty.	Order No.
<b>Neutral white</b>			
ZS 12/6 MC	12	400	1610020000
<b>Custom print white</b>			
ZS 12/6 MC	12	80	1610030000

## Terminal markers





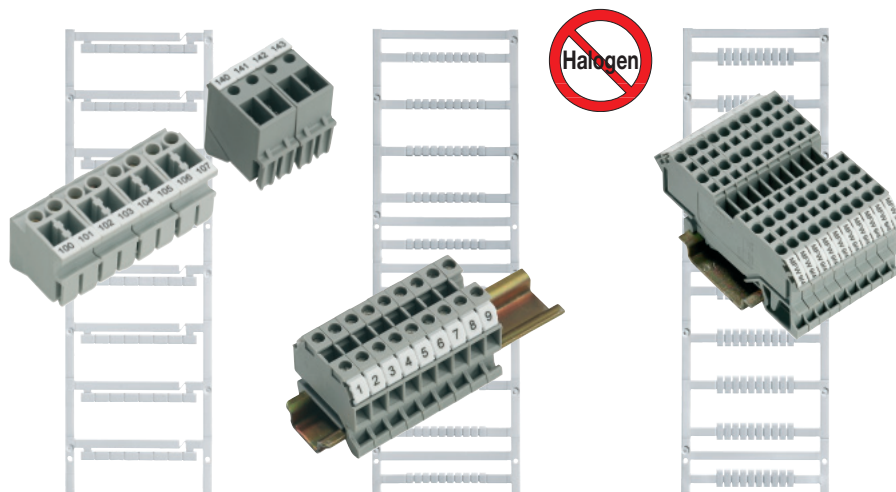

### MultiFit MF





MultiFit is Weidmüller's marker system for use with other makes of terminals with grids of 4 (NEW), 5, 6, 7.5 (NEW), 8 and 10 mm.

- Neutral markers for user to print with SMark-Laser, PrintJet, Plotter or MC-Mobilo
- Individually printed markers supplied based on customer CAD data or specifications
- One marker suitable for various makes of terminals



### Application options

							
<b>Wago</b>	●	●	●		● Similar to the WagoMini WSB Type 248-...264-...	● Similar to the Wago WSB Type 209-...249-...	● Similar to the Wago WMB Type 793-...794-...
<b>Phoenix</b>	●	●	●	● MF 5/5 Similar to the Phoenix Contact ZBF 5 MF 5/6 Similar to the Phoenix Contact ZBF 6 MF 5/4 Similar to the Phoenix ZBF 4			
<b>Wieland</b>	●	●	●				
<b>Legrand</b>	●	●	●		●	●	●
<b>entrelec</b>	●	●	●		●		
<b>Télémechanique</b>	●	●	●				

				
<b>Wago</b>				
<b>Phoenix</b>	● ZB 8	● ZB 10	● BN-ZB 7,5	
<b>Wieland</b>				
<b>Legrand</b>				
<b>entrelec</b>	●	●		
<b>Télémechanique</b>				
<b>Adels RKW</b>			● BZ 14	
<b>Cabur</b>				● Cabur

● = OK

(Please select the marker according to the width of the terminal)

### Number of characters when using plotter font

Pin size	0.18	0.25	0.35	0.18	0.25	0.35
Typeface (pt)	10	10	10	4	5	6
Tag width (mm)	<b>8</b>	4	4	4	9	7
Tag width (mm)	<b>10</b>	4	4	4	11	9
Tag width (mm)	<b>12</b>	5	5	5	13	11

### General notes:

The recommended applications given here do not release the user of the responsibility in individual cases from carrying out his own tests. Ensure when selecting the markers and terminals that the marker grids and terminal grids match or that the marker grid is smaller than the terminal grid.

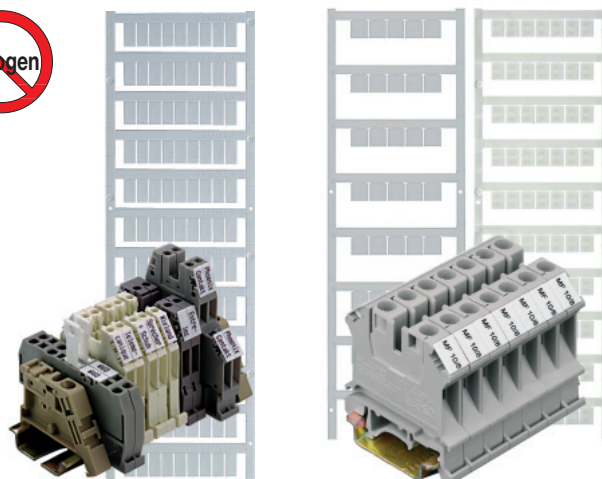

## Technical data

Material	Polyamide 66 / halogen-free		
Flammability class to UL94			V2
Temperature range °C			- 40...100
Colour	white		
Notes on mounting	– Assemble in strips when the marker width = terminal width – Assemble individually when the marker width < terminal width		
Possible printing systems	Plotter, SMark-Laser PrintJet, MC-Mobilo		

## Terminal width 4.0 mm MultiFit

Type	Length [mm]	Qty.	Order No.
<b>Neutral white</b>			
MF 5/4 MC	5.0	500	1877690000
MF-W 9/4 MC	9.0	500	1877730000
<b>Custom print white</b>			
MF 5/4 MC	5.0	500	1877670000
MF-W 9/4 MC	9.0	500	1877710000

## Terminal width 6.0 mm MultiFit

Type	Length [mm]	Qty.	Order No.
<b>Neutral white</b>			
MF 5/6 MC	5.0	500	1816260000
MF 9/6 MC	9.0	500	1816290000
MF 10/6 MC	10.0	600	1677220000
<b>Custom print white</b>			
MF 5/6 MC	5.0	500	1816330000
MF 9/6 MC	9.0	500	1816360000
MF 10/6 MC	10.0	120	1677230000

## Terminal width 8.0 mm MultiFit

Type	Length [mm]	Qty.	Order No.
<b>Neutral white</b>			
MF 10/8 MC	10.0	350	1868440000
<b>Custom print white</b>			
MF 10/8 MC	10.0	70	1868430000

## Terminal width 5.0 mm MultiFit

Type	Length [mm]	Qty.	Order No.
<b>Neutral white</b>			
MF 5/5 MC	5.0	500	1816250000
MF 5/5 MC Mini	5.0	500	1816240000
MF 8/5 MC	8.0	600	1677140000
MF 9/5 MC	9.0	500	1816270000
MF 9/5F MC	9.0	500	1816280000
MF 10/5 MC	10.0	600	1677160000
MF 10/5 MC Cabur	10.0	600	1854510000
MF 12/5 MC	12.0	600	1677180000
MF 12/5 MC Cabur	12.0	600	1854520000
<b>Custom print white</b>			
MF 5/5 MC	5.0	500	1816320000
MF 5/5 MC Mini	5.0	500	1816310000
MF 8/5 MC	8.0	120	1677150000
MF 9/5 MC	9.0	500	1816340000
MF 9/5F MC	9.0	500	1816350000
MF 10/5 MC	10.0	120	1677170000
MF 12/5 MC	12.0	120	1677190000

## Terminal width 7.5 mm MultiFit

Type	Length [mm]	Qty.	Order No.
<b>Neutral white</b>			
MF 5/7,5 MC	5.0	320	1877680000
<b>Custom print white</b>			
MF 5/7,5 MC	5.0	320	1877660000

## Terminal width 10.0 mm MultiFit

Type	Length [mm]	Qty.	Order No.
<b>Neutral white</b>			
MF 10/10 MC	10.0	200	1856760000
<b>Custom print white</b>			
MF 10/10 MC	10.0	40	1856770000

## Terminal markers

### Snap Mark

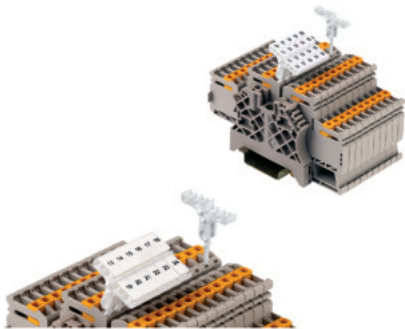

This tag rail was specially developed for the two-tier terminal IDK 1.5N available in the I-Series. The versatile hinge mechanism allows effortless mounting or removal of cross-connections. It can be equipped with four DEK 5 marking tags or two WS 10/5 Middle terminal markers.

#### Technical data

Tag carriers	
Material	Polyamide
Flammability class to UL94	V2
Temperature range °C	-40...100
Colour	white

Dimensions	
Length / width	23/5

#### Ordering data

Type	Length / Width [mm]	Qty.	Order No.
Snap Mark I	23/5	50	<b>1805880000</b>

### BZT1 / BZT2

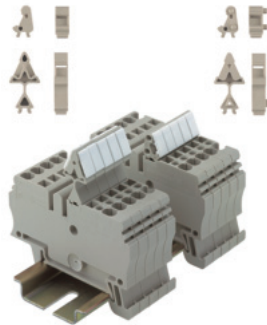

BZT marking tag rails are utilised for clear and unambiguous labelling of the ZDU 2.5/4/6 and ZDUA family of terminals. BZT marking tag rails are fitted with WS 10/5 terminal markers. By creating blocks of marking carriers, the ZA version offers maximum stability.

#### Technical data

Tag carriers	
Material	Polyamide
Flammability class to UL94	V2
Temperature range °C	-40...100
Colour	beige

Dimensions		Length/Width [mm]
BZT1		8/5
BZT2		12/5

#### Ordering data

Type	Length / Width [mm]	Qty.	Order No.
BZT 1	8/5	100	<b>1805490000</b>
BZT 1 ZA	8/5	100	<b>1805520000</b>
BZT 2	12/5	100	<b>1805480000</b>
BZT 2 ZA	12/5	100	<b>1805530000</b>

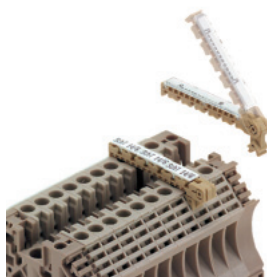

**SchT 9/4 / SchT 14/6**

SchT 9/4 and SchT 14/6 are hinged group marker carriers for individual Dekafix and WS tags that allow unhindered operation of the clamping screw.

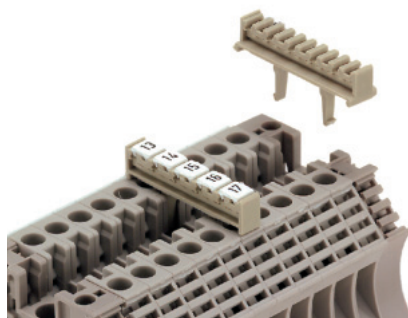
**WGB 5 / WGB 8**

Group marker carriers for individual Dekafix and WS tags. The WGB also cover the cross-connection channels.

**Technical data**

Tag carriers	
Material	Polyamide 66
Flammability class to UL94	V2
Temperature range °C	-40...100
Colour	beige

**Dimensions**

Length / width	44/6
----------------	------

**Technical data**

Tag carriers	
Material	Polyamide 66
Flammability class to UL94	V2
Temperature range °C	-40...100
Colour	beige

**Dimensions**

Length / width	34/5
----------------	------

**Ordering data**

Type	Length / Width [mm]	Qty.	Order No.
SCHT 14/6	44/6	20	<b>1269060000</b>
SCHT 9/4	32/4	20	<b>1278460000</b>

**Ordering data**

Type	Length / Width [mm]	Qty.	Order No.
WGB 5	34/5	50	<b>1050760000</b>
WGB 8	34/7.7	50	<b>1050960000</b>





WAGO

	MF-W 9/4	MF 5/5 mini	MF 9/5	MF 9/5 F	MF 9/6
<b>Feed-through terminals</b>					
264-701/704/706		X			
264-711/714/716		X			
264-721/724/726		X			
264-731/734/736		X			
264-120/125/220/225		X			
279-101/104	X				
279-604/621	X				
279-626/826	X				
279-681...686	X				
279-831...836	X				
279-901...906	X				
279-989...995	X				
280-101/104			X	X	
280-601/602			X	X	
280-603/633/634			X	X	
280-604/621/826/626			X	X	
280-641/651/654			X	X	
280-646/656/946			X	X	
280-653/671/672			X	X	
280-681/684/650			X	X	
280-830...835			X	X	
280-901...906			X	X	
280-989...995			X	X	
280-996...999			X	X	
280-691			X	X	
281-101/104					X
281-601/604					X
281-631/651					X
281-652...654					X
281-663/664/668					X
281-678/681/684					X
281-901/902/904					X
281-992...994/998/691					X
282-101/104					X
282-601/604					X
282-681/682/684/687					X
282-901/902/904/907					X
282-992/993/691					X
283-101/104					X
283-601/604/607					X
283-671/672/674/677					X
283-901/902/904/907					X
283-992/998/691					X
284-101/104					X
284-601/604/607					X
284-621/624					X
284-681/682/684/687					X
284-691/992/993					X
284-901/902/904/907					X
285-194/195					X
285-601/604/607					X
285-634/635		X			X
285-691					X
285-992/995					X
290-861/864/867			X	X	
780-992/993			X		
781-992/993					X
782-992					X
783-992					X
784-992					X
785-601/604/607/613					X
792... all	X				
812-140			X	X	X
859...all	X				
870-681/682/684	X				
870-831/832/834	X				
870-901/902/904	X				
870-911/912/914	X				
880-661/662/664	X	X			
880-681/682/684	X	X			
880-831/832/834	X	X			
880-901/902/904	X	X			
880-961/964/962	X	X			

	MF-W 9/4	MF 5/5 mini	MF 9/5	MF 9/5 F	MF 9/6
<b>Protective earth terminals</b>					
264-727		X			
264-737		X			
279-687	X				
279-837	X				
279-907	X				
280-107			X	X	
280-607			X	X	
280-637			X	X	
280-677			X	X	
280-687			X	X	
280-837			X	X	
280-907			X	X	
281-107					X
281-607					X
281-637					X
281-657					X
281-687					X
281-907					X
282-107					X
282-607					X
282-687					X
282-907					X
283-607					X
283-609					X
283-677					X
283-907					X
283-907					X
284-107					X
284-107					X
284-607					X
284-687					X
284-907					X
285-197					X
285-607					X
285-637	X				X
780-607			X	X	
780-637			X	X	
780-637					X
781-607					X
782-607					X
783-607					X
784-607					X
870-687		X			
870-837		X			
870-907		X			
870-917		X			
880-687		X	X		
880-837		X	X		
880-907		X	X		
<b>Fuse terminals</b>					
282-698					X
282-696					X
281-611/612/616/622					X
281-624/672					X
281-613/623					X
282-122					X
282-120					X
282-126					X
282-124					X
282-128					X
<b>Two-tier terminals</b>					
279-501/512/513	X				
279-504	X				
279-507	X				
279-508	X				
279-509	X				
279-517/527	X				
280-513			X	X	
280-517			X	X	
280-519/529			X	X	
280-520/530			X	X	
280-521/525			X	X	
280-522/526			X	X	
280-523/533			X	X	

	MF-W 9/4	MF 5/5 mini	MF 9/5	MF 9/5 F	MF 9/6
280-524/534			X	X	
280-527/537			X	X	
280-531			X	X	
280-532			X	X	
280-543			X	X	
281-619/629					X
281-620/630					X
870-101...104		X			
870-107		X			
870-108		X			
870-117/127		X			
870-501...504		X			
870-507		X			
870-508/509		X			
870-517/527		X			
870-531...534		X			
870-535/536		X			
870-537		X			
870-538/538		X			
870-826		X			
<b>Three- and four-tier terminals</b>					
280-549/551			X	X	
280-550			X	X	
280-552			X	X	
280-547/557/597			X	X	
280-548/558			X	X	
281-531/532		X			X
870-551/553		X			
870-556		X			
870-558/559/567/577		X			
870-557		X			
281-530					X
780-601/602/604			X	X	
780-631/651/654			X	X	
781-601/604					X
781-631/651					X
782-601/604					X
784-601/604					X
783-601/604					X
<b>Routing and potential terminals</b>					
727... all					X
280-675			X		
<b>Honeycomb elements</b>					
726... all			X		
<b>Single terminals</b>					
264-130/231			X		
264-131/230			X		
264-180264-280			X		
<b>Pluggable relays and bases</b>					
286... all		X			
786... all		X			
788... all			X		X
789... all		X			
<b>Multi-tier terminals</b>					
775-641			X	X	
775-642/649			X	X	
775-646			X	X	
775-645			X	X	
777-641					X
777-642					X
777-646					X
777-645					X
777-648					X
777-647					X
777-649					X
777-651					X
777-650					X
777-652					X
776-641					X
776-645/646					X
776-649/642					X
776-650/651					X

Individual tag mounting only when terminal grid > 6 mm

	MF-W 9/4	MF 5/5 mini	MF 9/5	MF 9/5 F	MF 9/6
<b>Disconnect test terminal</b>					
280-612/614			X	X	
280-622/623/627			X	X	
280-649/676/685/695			X	X	
280-683			X	X	
280-805/836/829/839			X	X	
280-868/870/876/879		X	X		
280-869/871/880		X	X		
280-874/881/883/885		X	X		
280-875/882/884		X	X		
280-912...914			X		
281-659/660					X
281-666					X
281-683					X
281-912					X
282-131					X
282-133					X
282-135					X
282-138...141					X
282-694/699					X
282-811/821		X			X
282-860					X
282-865					X
282-866282-695/697					X
282-870					X
781-613/623			X	X	
781-643/653					X
782-613/623					X
783-613/623					X
784-613/623					X
<b>Initiator terminals</b>					
269-560		X			
269-570		X			
269-574		X			
270-560/564		X			
270-570/574		X			
270-572/577		X			
270-585/586		X			
280-553/560			X	X	
280-559			X	X	
280-561			X	X	
280-563			X	X	
280-564			X	X	
280-567			X	X	
280-570			X	X	
280-571			X	X	
280-573			X	X	
280-574			X	X	
280-577			X	X	
280-580			X	X	
280-582			X	X	
280-584			X	X	
280-584			X	X	
280-588			X	X	
<b>Actuator terminals</b>					
269-572		X			
269-585		X			
280-515			X	X	
280-554			X	X	
280-555			X	X	
280-556			X	X	
280-562			X	X	
280-565			X	X	
280-566			X	X	
280-568			X	X	
280-572			X	X	
280-575			X	X	
280-576			X	X	
280-578			X	X	
280-583			X	X	
280-585			X	X	
280-586			X	X	
280-592			X	X	
280-593			X	X	

	MF-W 9/4	MF 5/5 mini	MF 9/5	MF 9/5 F	MF 9/6	
<b>Diode and LED terminals</b>						
279-620	X					
279-623	X					
279-624	X					
279-673	X					
279-674	X					
279-809	X					
279-815	X					
279-915	X					
280-613			X	X		
280-615			X	X		
280-623			X	X		
280-624			X	X		
280-655			X	X		
280-658			X	X		
280-673			X	X		
280-809			X	X		
280-815			X	X		
280-915			X	X		
280-940			X	X		
280-941			X	X		
280-942			X	X		
280-943			X	X		
281-603					X	
281-633					X	
281-634					X	
281-635					X	
281-636					X	
281-665					X	
281-673					X	
281-915					X	
870-540		X				
870-541		X				
870-542		X				
870-543		X				
870-590		X				
870-593		X				
870-596		X				
<b>X-Com system</b>						
769-... all		X				
<b>I/O modules TOPLON</b>						
750-... all		X			X	
<b>Siemens</b>						
	MF-SI 8/5	MF-SI 10/5	MF-SI 8/6	MF-SI 10/6	MF-SI 8/6-5	MF-SI 10/6-5
8WA1 011-0DG...					X	X
8WA1 011-1BG...					X	X
8WA1 011-1DG...					X	X
8WA1 011-1NG...					X	X
8WA1 011-1PG...					X	X
8WA1 011-6EG...					X	X
8WA2 011-1BF...	X	X				
8WA2 011-1BG...			X	X		
8WA2 011-1DF...	X	X				
8WA2 011-1DG...			X	X		
8WA2 011-1EF20	X	X				
8WA2 011-1LF20	X	X				
8WA2 011-1NG23			X	X		
8WA2 011-1PF...	X	X				
8WA2 011-1PG...			X	X		
8WA2 011-2BG...			X	X		
8WA2 011-2DG...			X	X		
8WA2 011-3JG...			X	X		
8WA2 011-6EG...			X	X		

	MF 5/7,5	MF 5/5 mini	ESG 8/11	GWS 5/5	GWS 9/5	GWS 12/5	GWS 9/6	GWS 12/6
<b>Adels</b>								
RKV- transformer terminal	X							
<b>Beckhoff</b>								
I/O modules	X							
<b>Woertz</b>								
2711/60	X							
30041								X
30128								X
30143								X
30168								X
30172								X
30176								X
30191								X
30195								X
30228								X
30432							X	
30810				X				
30870							X	
30880							X	
30903				X				
33100								X
30005...9								X
30123...130								X
30137...8								X
30145...								X
30150...				X				
30197/200								X
30290...1								X
30400...405				X				
30430...							X	
30431...							X	
30544...								X
30800...								X
30840...44								X
30860...				X				
30890...1							X	
30902...							X	
30930...								X
30950...2							X	
3410...							X	
3424...9								X
3430...							X	
3436...8								X
3440...								X
3450...								X
3452...								X
3472/73/77								X
35310/3...50/3				X	X			
35310/4...90/4							X	X
35370/2...				X				

Individual tag mounting only when terminal grid > 6 mm



## Entrelec

	MF 5/5 mini	MF 10/5	MF 10/6	MF 10/8	MF 10/10
41 H LT...	X				
62 H...	X				
D 1,5/6...	X				
D 2,5/5...	X				
D 2,5/6...	X				
D 2,5/8...	X				
D 4/6...	X				
D 4/8...	X		X		
D 4/8	X				
DB 1,5/6...	X				
DB 2,5/8...	X				
DB 4/6...	X				
DB 4/8...	X				
DH 1,5/6...	X				
DH 2,5/8...	X				
DH 4/6...	X				
DH 4/8...	X				
DL 10/17,5...	X				
DR 1,5/5...	X				
DR 1,5/6...	X				
DR 2,5/10...	X				
DR 2,5/5...	X				
DR 2,5/8...	X				
DR 4/6...	X				
DR 4/8...	X				
DS 1,5/6...	X				
DS 2,5/8...	X				
DS 4/6...	X				
DS 4/8...	X				
H 1/10...	X				
HD 2,5/6...	X				
HD 6/14...	X				
HD 6/8...	X				
HD 6/9...		X			
M 10/10...					X
M 10/16...			X	X	X
M 10/22...			X	X	X
M 16/12...			X	X	X
M 35/16...			X	X	X
M 4/6...			X		
M 4/7...			X		
M 4/8...				X	
M 4/9...			X	X	
M 6/8...				X	
M 70/22...			X	X	X
M 95/26...			X	X	X
MA 2,5/5...		X			
MB 10/10...					X
MB 10/13...			X	X	X
MB 10/14,5...			X	X	X
MB 10/24...			X	X	X
MB 25/30...			X	X	X
MB 4/6...			X		
MB 6/8...				X	
MB 70/10...					X
MS 6/8...				X	
MS4/6...			X		
MTC 6			X		
T 1,5/5...	X				
T 2,5/5...	X				
T 2,5/6...	X				
T 4/6...	X				

## Wieland

	MF-W 9/4	MF 5/5 mini	MF 9/5	MF 9/5 F	MF 9/6
9700 A/5...	X				
9700 B...				X	
9701 A/6...A/16				X	
9760 U...				X	
9785 U...				X	
9786 U...				X	
AKB...	X	X	X		
AKT...	X	X	X		
Terminal Adapter...	X	X	X		
UET...	X	X	X		
WEB...	X	X	X		
WEG...	X	X	X		
WK / WKN 10...				X	
WK / WKN 16...150				X	
WK / WKN 2,5...	X	X	X		
WK / WKN 4...				X	
WK / WKNn 6...				X	
WK/3-6...				X	
WK/4-8...				X	
WKB 2,5...	X	X	X		
WKF 1,5...	X	X	X		
WKF 10...				X	
WKF 16...				X	
WKF 2,5...	X	X	X		
WKF 4...				X	
WKF 6...				X	
WKI 10...35				X	
WKI 4...				X	
WKM 2,5...	X	X	X		
WKM 4...					

## Cabur

	MF 10/5 Cabur	MF 12/5 Cabur
CBD.2...70	X	X
TLS.2...	X	X
TLD.2...	X	X
CBR.2...	X	X
DCS.4...	X	X
DAS.4...	X	X
SPO.4...	X	X
SCB.4...6	X	X
VLO.4...	X	X
SDO.4...	X	X
SRO.4...	X	X
SZO.4...	X	X
SFR.4...	X	X
SFO.4...	X	X
FPC.10...	X	X
FPL.10...	X	X
TC/PO...	X	X
MPS.2...	X	X
AFO.2...	X	X
PDF.2...	X	X
FDP.2...	X	X
VPC.2...	X	X
CVF.4...	X	X
FFS.4...	X	X
FVS.4...	X	X
MAC.6...	X	X
CAM...	X	X
RN.1...	X	
RFI.2...	X	
RN.4...	X	
RP.4...	X	
TR.4...	X	X
TE.4...35	X	X
CBE.2...	X	

## Wire and cable markers

Weidmüller's range of wire and cable markers provides users with solutions for a wide variety of applications. The applications range from thin wires through to cables with large external diameters. Amongst others, the assortment includes combination systems with individual tags, transparent sleeves and markers that are fastened using cable ties.

Open and closed, printed or neutral markers for individual printing are available.

Systems are available for:

- Clip-on ready-to-use printed markers according to individual marking requirements
- Marking by digits from a standard set of characters
- Combination of individual pre-printed digits to form a character code
- Customer prints utilising one of the following options: SMark-Laser printer, PrintJet printer, laser printer, plotter, thermal transfer, Matrix printer or pen.

Halogen-free and practically free of pollutants, Weidmüller's wire and cable markers comply with both European and in-house standards of well-known system manufacturers.

A sample selection is available in Weidmüller's sample bag of wire and cable markers: order no. **1640420000**.

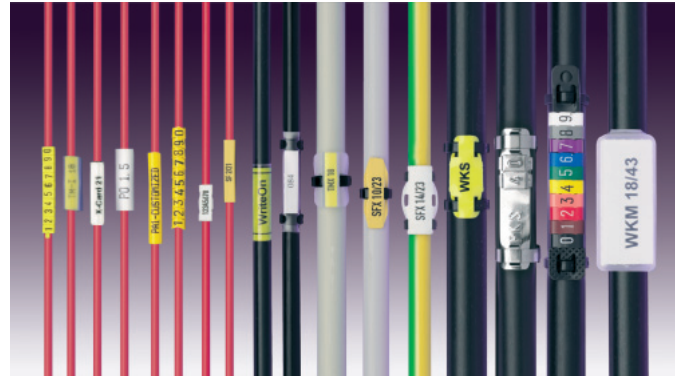



# Matrix wire and cable markers

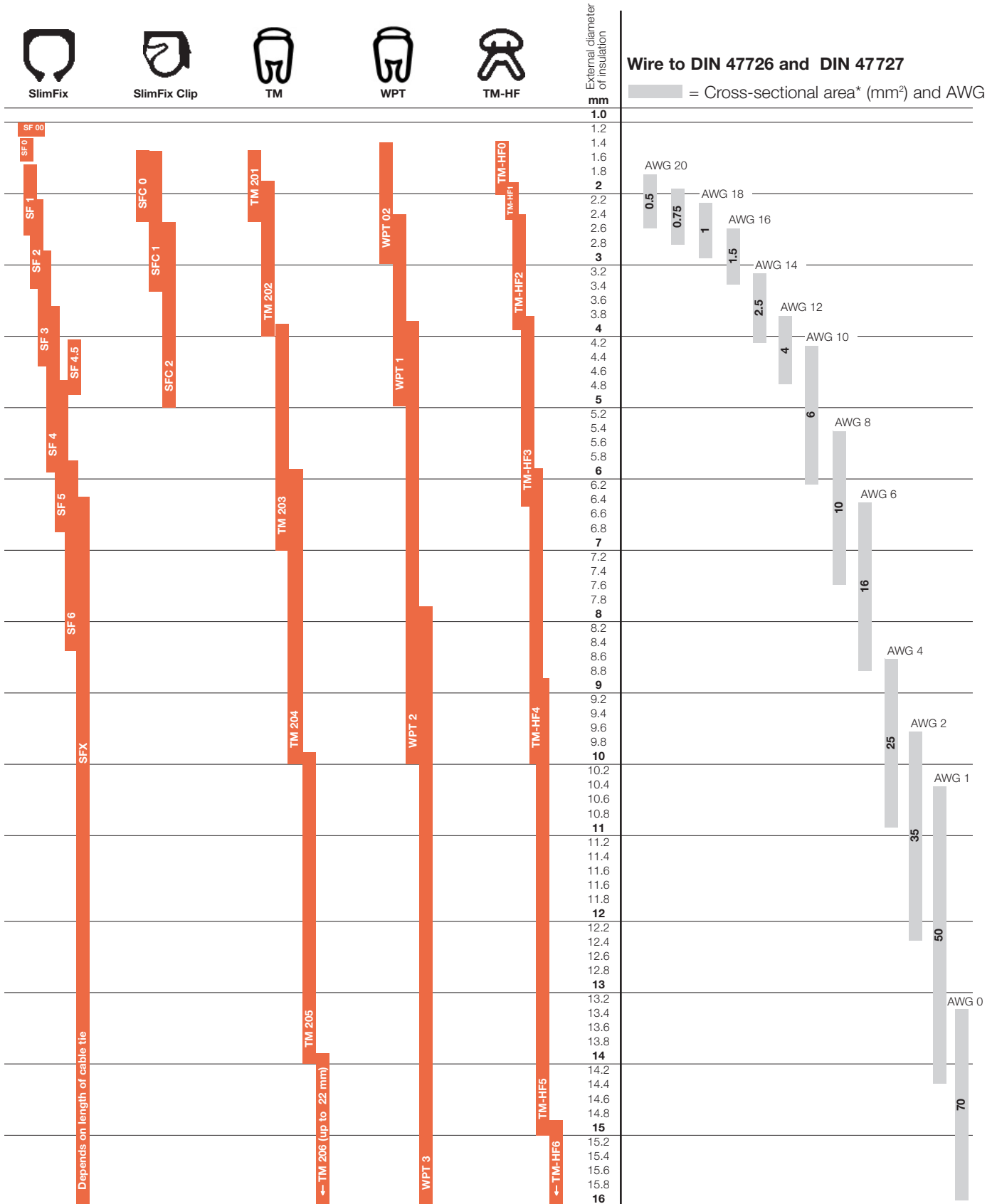

\* Non-binding reference values. Please take into consideration the external diameter of the insulation.

## SlimFix

SlimFix are wire and cable markers featuring a space-saving design. The markers can also be attached to the wires after these have been installed. They are made from halogen-free material and fulfil flammability class VO requirements. SlimFix is an approved and listed marker for traffic engineering. Attaching even small markers is no problem when using the SF tool.

- Halogen-free material
- Flammability class VO/V2
- Approved and listed markers, includes traffic engineering
- Attach to conductor cross-sections greater than 16.0 mm<sup>2</sup> with cable ties
- Markers available in the proven MultiCard format

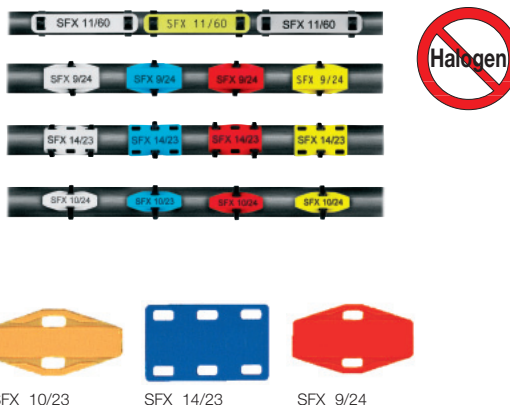

## Technical data

SF/SFX	
Material	Wemid / Polyamide
Flammability class to UL94	VO/V2
Temperature range	V0: -50 °C... 120 °C/V2: -40 °C... 100 °C
Possible printing systems	Plotter, SMark-Laser, PrintJet, MC-Mobilo
Colour	white, yellow, blue, red, green (grey)
Notes on mounting	SF: Slide onto unconnected wires; attach to connected wires using SlimFix tool SFX: Attach using cable ties

## Selection table

Type	Cond. ext. Ø. (max.) mm	Cond. cross-section mm <sup>2</sup>
SF 00	1.0...1.3	< 0.25
SF 0	1.3...1.6	0.25...0.5
SF 1	1.6...2.1 (2.7)	0.5...0.75
SF 2	2.1...2.9 (3.4)	0.75...1.5
SF 3	2.9...3.6 (4.5)	1.5...2.5
SF 4	3.6... 4.5 (6.0)	2.5...4.0
SF 4,5	4.1...4.9	4.0...6.0
SF 5	4.7...5.8 (6.8)	6.0...10.0
SF 6	5.8...7.0 (8.5)	10.0...16.0
SFX	from 7.0	from 16.0

SFX only: max. width of cable tie = 3.6 mm

## Ordering information

Minimum order quantity	1 Qty.
For custom print, provide details of colour and print.	

## Number of characters when using plotter font

Pin size	0.18	0.25	0.35	0.18	0.25	0.35
Font size (pt)	10	10	10	4	5	6
Tag width (mm) <b>12</b>	5	5	5	13	11	9
Tag width (mm) <b>21</b>	10	10	10	24	19	16

## Printing system

The IP-220 standard plotter (**1674820000**) and the MultiCard support frame (**1610040000**) can be used for printing the sizes SF00, SF0, SF 1, SF 2, SF 3 and SFX. The plotter IP-22 special (**1674810000**) and the specified support frames are required to be able to print the complete assortment of SlimFix markers.

## Ordering data

## SFX neutral

23.0 mm	Qty.	Order No.				
		white	yellow	blue	red	grey
SFX 10/23 V0	160	1727750001	1727750004	1727750002	1727750003	
SFX 10/23 V2	160	1852390000	1852360000	1852400000	1852370000	
SFX 14/23 V0	160	1713660001	1713660004	1713660002	1713660003	
SFX 14/23 V2	160	1852440000	1852410000	1852450000	1852420000	
24.0 mm	Qty.	Order No.				
		white	yellow	blue	red	grey
SFX 9/24 V0	160	1696140001	1696140004	1696140002	1696140003	
SFX 9/24 V2	160	1852490000	1852460000	1852500000	1852470000	
60.0 mm	Qty.	Order No.				
SFX 11/60	60	1860120000	1860150000			1860130000

## Ordering data

## SFX custom print

## Ordering data

## SlimFix Tool

23.0 mm	Qty.	Order No.	SlimFix Tool		
			Qty.	Order No.	
SFX 10/23 V0	32	1727760000	SF-Tool 1	10	1782970000
SFX 10/23 V2	32	1852380000	SF-Tool 2-3	10	1782960000
SFX 14/23 V0	32	1713670000	SF-Tool 4-5	10	1782980000
SFX 14/23 V2	32	1852430000	SF tool assortment	1	1770080000
24.0 mm	Qty.	Order No.			
SFX 9/24 V0	32	1689500000			
SFX 9/24 V2	32	1852480000			
60.0 mm	Qty.	Order No.			
SFX 11/60	12	1860140000			

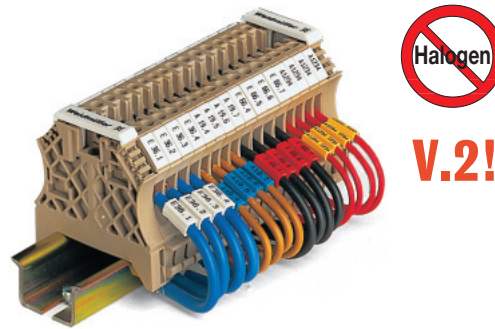

**Technical data**

Material	Polyamide
Flammability class to UL94	V2
Temperature range °C	-40...100

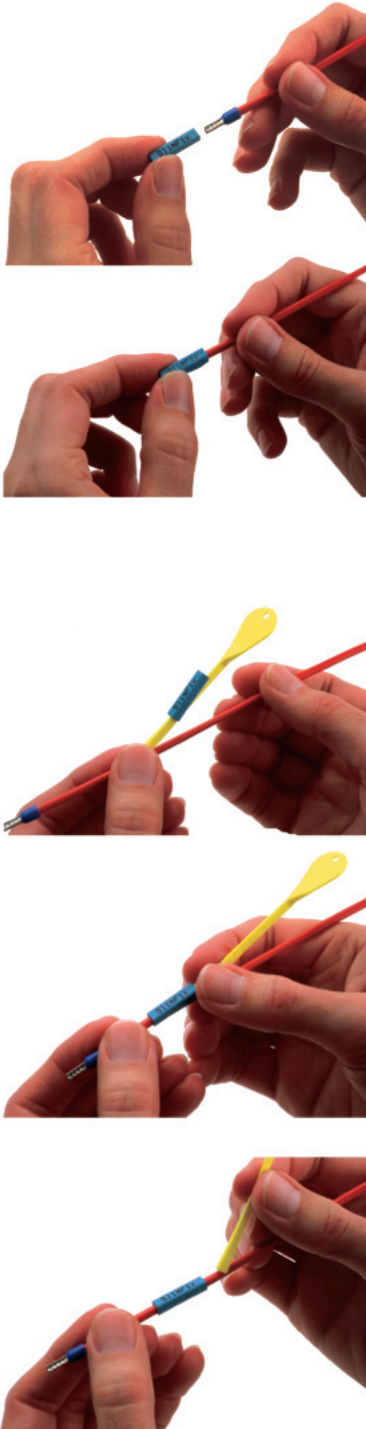

**SlimFix Neutral**

	Max. ext. diameter of wire [mm]	Max. cond. cross-section [mm²]	Qty.	Order No.			
				white	yellow	blue	red
<b>Length: 12 mm</b>							
SF 00/12	1.0...1.3	...0.25	400	1740830001	1740830004	1740830002	1740830003
SF 0/12	1.3...1.6	0.25...0.5	400	1724050001	1724050004	1724050002	1724050003
SF 1/12	1.6...2.1	0.50...0.75	400	1711320001	1711320004	1711320002	1711320003
SF 2/12	2.1...2.9	0.75...1.5	400	1711350001	1711350004	1711350002	1711350003
SF 3/12	2.9...3.6	1.50...2.5	320	1711370001	1711370004	1711370002	1711370003
SF 4/12	3.6...4.5	2.50...4	128	1743490001	1743490004	1743490002	1743490003
SF 5/12	4.7...5.8	4.00...6	160	1743500001	1743500004	1743500002	1743500003
<b>Length: 21 mm</b>							
SF 00/21	1.0...1.3	...0.25	400	1740840001	1740840004	1740840002	1740840003
SF 0/21	1.3...1.6	0.25...0.5	400	1740850001	1740850004	1740850002	1740850003
SF 1/21	1.6...2.1	0.50...0.75	400	1696090001	1696090004	1696090002	1696090003
SF 2/21	2.1...2.9	0.75...1.5	400	1696100001	1696100004	1696100002	1696100003
SF 3/21	2.9...3.6	1.50...2.5	320	1696110001	1696110004	1696110002	1696110003
SF 4/21	3.6...4.5	2.50...4	192	1696120001	1696120004	1696120002	1696120003
SF 4,5/21	4.1...4.9	4.00...6	96	1740860001	1740860004	1740860002	1740860003
SF 5/21	4.7...5.8	6.00...10	160	1696130001	1696130004	1696130002	1696130003
SF 6/21	5.8...7.0	10.00...16	160	1740870001	1740870004	1740870002	1740870003

**SlimFix custom print**

	Max. ext. diameter of wire [mm]	Max. cond. cross-section [mm²]	Qty.	Order No.
<b>Length: 12 mm</b>				
SF 00/12	1.0...1.3	...0.25	80	1740880000
SF 0/12	1.3...1.6	0.25...0.5	80	1724060000
SF 1/12	1.6...2.1	0.50...0.75	80	1711330000
SF 2/12	2.1...2.9	0.75...1.5	80	1711360000
SF 3/12	2.9...3.6	1.50...2.5	64	1711380000
SF 4/12	3.6...4.5	2.50...4	32	1748920000
SF 5/12	4.7...5.8	4.00...6	32	1748930000
<b>Length: 21 mm</b>				
SF 00/21	1.0...1.3	...0.25	80	1740890000
SF 0/21	1.3...1.6	0.25...0.5	80	1740900000
SF 1/21	1.6...2.1	0.50...0.75	80	1689400000
SF 2/21	2.1...2.9	0.75...1.5	80	1689420000
SF 3/21	2.9...3.6	1.50...2.5	64	1689440000
SF 4/21	3.6...4.5	2.50...4	48	1689460000
SF 4,5/21	4.1...4.9	4.00...6	32	1740910000
SF 5/21	4.7...5.8	6.00...10	32	1689480000
SF 6/21	5.8...7.0	10.00...16	32	1740920000

**SlimFix**

SlimFix are wire and cable markers featuring a space-saving design. The markers can also be attached to the wires after these have been installed. They are made from halogen-free material and fulfil flammability class VO requirements. SlimFix is an approved and listed marker for traffic engineering. Attaching even small markers is no problem when using the SF tool.

- Halogen-free material
- Flammability class V0/V2
- Approved and listed markers, includes traffic engineering
- Attach to wire cross-sections above 16.0 mm<sup>2</sup> with cable ties
- Markers available in the proven MultiCard format



**Technical data**

Material	Polyamide 6.6
Flammability class to UL94	VO
Temperature range °C	-50...120 °C

**SlimFix Neutral**

Length: 12 mm	Qty.	Order No.			
		white	yellow	blue	red
VT SF 00/12	800	1752200001	1752200004	1752200002	1752200003
VT SF 0/12	800	1752110001	1752110004	1752110002	1752110003
VT SF 1/12	800	1718470001	1718470004	1718470002	1718470003
VT SF 2/12	800	1718480001	1718480004	1718480002	1718480003
VT SF 3/12	640	1718490001	1718490004	1718490002	1718490003
VT SF 4/12	192	1746030001	1746030004	1746030002	1746030003
VT SF 5/12	160	1746040001	1746040004	1746040002	1746040003

Length: 21 mm	Qty.	Order No.			
		white	yellow	blue	red
VT-SF 00/21	800	1730580001	1730580004	1730580002	1730580003
VT-SF 0/21	800	1730590001	1730590004	1730590002	1730590003
VT SF 1/21	800	1689390001	1689390004	1689390002	1689390003
VT SF 2/21	800	1689410001	1689410004	1689410002	1689410003
VT SF 3/21	512	1689430001	1689430004	1689430002	1689430003
VT SF 4/21	288	1689450001	1689450004	1689450002	1689450003
VT-SF 4.5/21	192	1730570001	1730570004	1730570002	1730570003
VT SF 5/21	160	1689470001	1689470004	1689470002	1689470003
VT-SF 6/21	160	1730560001	1730560004	1730560002	1730560003

**SlimFix custom print**

	Qty.	Order No.
VT-SF 0/21	80	1888850000
VT-SF 1/21	80	1789230000
VT-SF 2/21	80	1789240000
VT-SF 3/21	64	1789250000
VT-SF 4/21	48	1789260000
VT-SF 4.5/21	32	1789270000
VT-SF 5/21	32	1789280000
VT-SF 6/21	32	1789290000



### SlimFix Clip

The SlimFix Clip combines two advantages in one: its unique closure mechanism offers the reliability of a closed marker with ease of attaching an open marker. The Clip closure mechanism also allows quick, no fuss attachment of the markers after the wires have been installed. SlimFix Clip markers are suitable for wires and cables with external diameters up to 5 mm. Long sequences of characters are possible on the large marking surface – up to 30 mm.

- Halogen free, flammability class V2 material
- Narrow markers with reliable attachment thanks to compensation feature
- Clip closure mechanism ensures permanent attachment following wire installation
- Rapid attachment without tools
- Three sizes for wire cross-sections from 0.5 – 4.0 mm<sup>2</sup>
- Available in lengths of 12, 21 and 30 mm
- Markers available in the proven MultiCard format
- Additional marking surface for precise assignment to projects
- Custom-printed markers supplied to your specifications

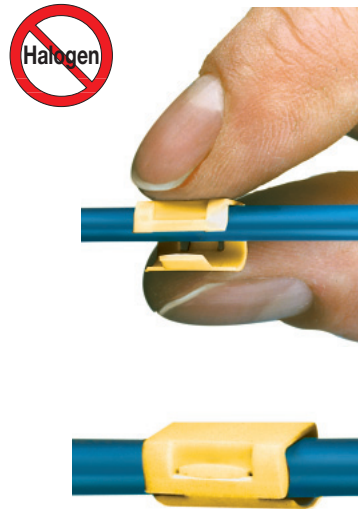

### Selection table

Type	Wire, ext. $\phi$	Wire cross-section
SFC 0	1.5 – 2.5 mm	0.5 – 1.0 mm <sup>2</sup>
SFC 1	2.0 – 3.5 mm	0.75 – 2.5 mm <sup>2</sup>
SFC 2	2.5 – 5.0 mm	2.5 – 4.0 mm <sup>2</sup>

### Ordering information

Minimum order quantity	1 Qty.
------------------------	--------

### Number of characters when using plotter font

Pin size	0.18	0.25	0.35	0.18	0.25	0.35	
Typeface (pt)	10	10	10	4	5	6	
Tag width (mm)	<b>12</b>	5	5	5	13	11	9
Tag width (mm)	<b>21</b>	10	10	10	24	19	16

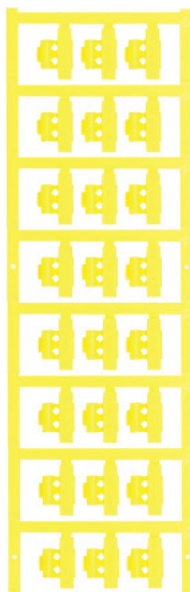
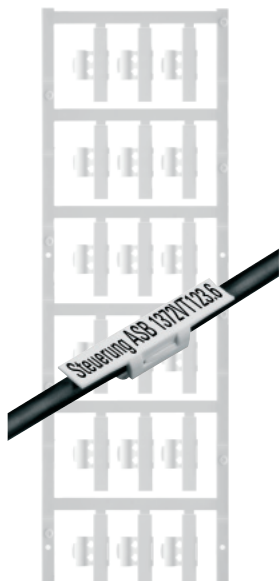

**Technical data**

Material	Polyamide 66
Flammability class to UL94	V2
Temperature range °C	-40...100
Dimensions	12 mm, 21 mm and 30 mm lengths
	SFC 1/12, for example, size 1, length 12 mm
Colour	white, yellow, blue, red
Possible printing systems	SMark-Laser, PrintJet; please refer to printer systems
Notes on mounting	Attach to unconnected and connected wires

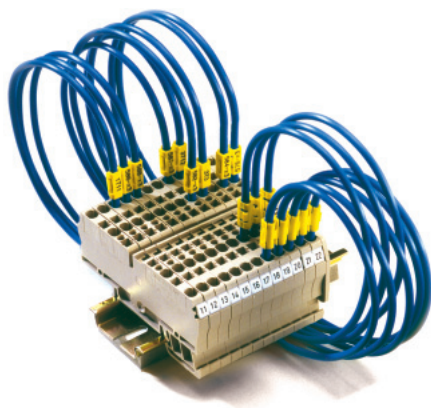

**SFC Neutral**

	Max. ext. diameter of wire [mm]	Max. cond. cross-section [mm <sup>2</sup> ]	Qty.	Order No.			
<b>Length: 12.0 mm</b>							
SFC 0/12	1.5...2.5	0.5...1.0	200	white	yellow	blue	red
SFC 1/12	2...3.5	0.75...2.5	200	1747320001	1747320004	1747320002	1747320003
SFC 2/12	2.5...5.0	2.5...4.0	120	1758320001	1758320004	1758320002	1758320003
<b>Length: 21.0 mm</b>							
SFC 0/21	1.5...2.5	0.5...1.0	200	white	yellow	blue	red
SFC 1/21	2...3.5	0.75...2.5	200	1813190000	1813210000	1813220000	1813200000
SFC 2/21	2.5...5.0	2.5...4.0	120	1779080001	1779080004	1779080002	1779080003
SFC 2/21	2.5...5.0	2.5...4.0	120	1805810000	1805780000	1805770000	1805790000
<b>Length: 30.0 mm</b>							
SFC 0/30	1.5...2.5	0.5...1.0	150	white	yellow	blue	red
SFC 1/30	2...3.5	0.75...2.5	150	1813240000	1813260000	1813270000	1813250000
SFC 2/30	2.5...5.0	2.5...4.0	90	1805760000	1805730000	1805720000	1805740000
SFC 2/30	2.5...5.0	2.5...4.0	90	1805870000	1805830000	1805820000	1805850000

**SFC custom print**

	Max. ext. diameter of wire [mm]	Max. cond. cross-section [mm <sup>2</sup> ]	Qty.	Order No.
<b>Length: 12.0 mm</b>				
SFC 0/12	1.5...2.5	0.5...1.0	40	1813180000
SFC 1/12	2...3.5	0.75...2.5	40	1752720000
SFC 2/12	2.5...5.0	2.5...4.0	24	1763480000
<b>Length: 21.0 mm</b>				
SFC 0/21	1.5...2.5	0.5...1.0	40	1813230000
SFC 1/21	2...3.5	0.75...2.5	40	1779090000
SFC 2/21	2.5...5.0	2.5...4.0	24	1805800000
<b>Length: 30.0 mm</b>				
SFC 0/30	1.5...2.5	0.5...1.0	30	1813280000
SFC 1/30	2...3.5	0.75...2.5	30	1805750000
SFC 2/30	2.5...5.0	2.5...4.0	18	1805860000

TM sleeve

Transparent sleeves



The extensive assortment of TM sleeves is suitable for universal use:

It covers a wide range of applications from narrow wires through to cables with large external diameters.

The assortment offers unrivalled protection for printed insert tags against external influences.

Available in five different lengths and nine sizes, TM sleeves are easy to attach

- A tag type for all sleeves
- Optimum protection of printed insert tags
- Wide range of applications for wires and cables
- A tag type for all cross-sections

Technical data

Material	PVC
Flammability class to UL 94	V 0
Temperature range	-50 ... +80 °C
Dimensions	Lengths 12 mm, 15 mm, 18 mm, 20 mm, 30 mm
Colour	Transparent
Possible marking systems	Insert tag TM-I, or PF
Minimum order quantity	1 Qty.

Ordering information

TM

Type	Insulation, ext. Ø	Cond. cross-sec.
TM 201	1.5 – 2.5 mm	0.25 – 1.5 mm <sup>2</sup>
TM 202	2.0 – 4.0 mm	0.5 – 2.5 mm <sup>2</sup>
TM 203	4.0 – 7.0 mm	2.5 – 10.0 mm <sup>2</sup>
TM 204	6.0 – 10.0 mm	6.0 – 16.0 mm <sup>2</sup>
TM 205	10.0 – 14.0 mm	16.0 – 35.0 mm <sup>2</sup>
TM 206	14.0 – 22.0 mm	35.0 – 120.0 mm <sup>2</sup>
TM 207	22.0 – 30.0 mm	120.0 – 240.0 mm <sup>2</sup>
TM 208	30.0 – 35.0 mm	240.0 – 300.0 mm <sup>2</sup>
TM 209	35.0 – 40.0 mm	300.0 – 500.0 mm <sup>2</sup>

This data is provided as a guideline. It refers exclusively to the diameter of the cable. Differing insulation materials can deviate considerably from the above values.

Ordering data

TM

Type	Qty.	Order No.
TM 201/12	1000	1798640000
TM 202/12	1000	1798560000
TM 203/12	500	1798510000
TM 204/12	500	1806180000
TM 205/12	200	1806190000
TM 206/12	200	1806200000
TM 207/12	50	1806210000
TM 208/12	50	1806220000
TM 209/12	50	1806230000
TM 201/15	1000	1798620000
TM 202/15	1000	1798540000
TM 203/15	500	1798490000
TM 204/15	500	1806240000
TM 205/15	200	1806250000
TM 206/15	200	1806260000
TM 207/15	50	1806270000
TM 208/15	50	1806280000
TM 209/15	50	1806290000
TM 201/18	1000	1798600000
TM 202/18	1000	1798530000
TM 203/18	500	1798480000
TM 204/18	500	1806300000
TM 205/18	200	1806310000
TM 206/18	200	1806320000
TM 207/18	50	1806330000
TM 208/18	50	1806340000
TM 209/18	50	1806350000

Ordering data

TM

Type	Qty.	Order No.
TM 201/20	1000	1798580000
TM 202/20	1000	1798520000
TM 203/20	500	1798470000
TM 204/20	500	1806360000
TM 205/20	200	1806370000
TM 206/20	200	1806380000
TM 207/20	50	1806390000
TM 208/20	50	1806400000
TM 209/20	50	1806410000
TM 201/30	500	1874850000
TM 202/30	500	1874760000
TM 203/30	200	1874770000
TM 204/30	200	1874780000
TM 205/30	200	1874790000
TM 206/30	100	1874800000
TM 207/30	50	1874820000
TM 208/30	50	1874830000
TM 209/30	50	1874720000



**TM-HF sleeve**

**Transparent sleeves**



TM sleeves are halogen free and practically free from pollutants. The sleeves can be fitted with insert tags TM-I 12 or TM-I 18. They offer a wide range of applications for cables and wires. This system has proven particularly successful in traffic engineering. The slim design guarantees a secure attachment to the wire.

- Halogen-free
- Slim design guarantees secure attachment to the wire.

**Technical data**

Material	Polyethylene PE-LD
Flammability class to UL 94	HB
Temperature range	-20 ... + 80 °C
Dimensions	Length: 12 mm and 18 mm
Colour	Transparent
Possible marking systems	Insert tag TM-I 12 and 18
Minimum order quantity	1 Qty.

**Ordering data**

Type	Qty.	Order No.
TM 0/12 HF	1000	1719760000
TM 1/12 HF	1000	1719780000
TM 2/12 HF	1000	1719800000
TM 3/12 HF	500	1719820000
TM 4/12 HF	500	1719840000
TM 5/12 HF	200	1719860000
TM 6/12 HF	200	1719880000
TM 0/18 HF	1000	1719770000
TM 1/18 HF	1000	1719790000
TM 2/18 HF	1000	1719810000
TM 3/18 HF	500	1719830000
TM 4/18 HF	500	1719850000
TM 5/18 HF	200	1719870000
TM 6/18 HF	200	1719890000

**TMX-HF sleeve**

**Transparent sleeves**



TMX rounds Weidmüller's extensive assortment of sleeves. By utilising cable ties, the transparent, halogen-free TMX sleeves can be fitted to any size of wire. The TMX sleeve is fitted with the insert tag TM-I 18. It is designed for a wide range of applications. The TMX sleeves are suitable for cables and wires with an external diameter from 15 mm and upwards. Cable ties guarantee secure attachment.

- Halogen-free
- Secure attachment with cable ties

**Technical data**

Material	Polyethylene PE-LD
Flammability class to UL 94	HB
Temperature range	-20 ... + 80 °C
Dimensions	Length: 18 mm
Colour	Transparent
Possible marking systems	Insert tag TM-I 18
Please refer to page 46 for CB cable ties	
Max. width of cable tie	4.8 mm
Minimum order quantity	1 Qty.

**Ordering information**

Type	Insulation, ext. Ø	Cond. cross-sec.
TM-HF 0	1.3 – 2.0 mm	0.22 – 0.5 mm <sup>2</sup>
TM-HF 1	1.8 – 2.5 mm	0.5 – 1.5 mm <sup>2</sup>
TM-HF 2	2.5 – 4.0 mm	0.75 – 2.5 mm <sup>2</sup>
TM-HF 3	4.0 – 6.5 mm	2.5 – 6.0 mm <sup>2</sup>
TM-HF 4	6.0 – 10.0 mm	10.0 – 35 mm <sup>2</sup>
TM-HF 5	9.0 – 15.0 mm	25.0 – 70 mm <sup>2</sup>
TM-HF 6	15.0 – 24.0 mm	35.0 – 150 mm <sup>2</sup>

**Ordering information**

Type	Insulation, ext. Ø	Cond. cross-sec.
TMX	15.0 mm	25 mm <sup>2</sup>

**Ordering data**

Type	Qty.	Order No.
TMX	500	1748820000

**Twin sleeve**

**Transparent sleeves**

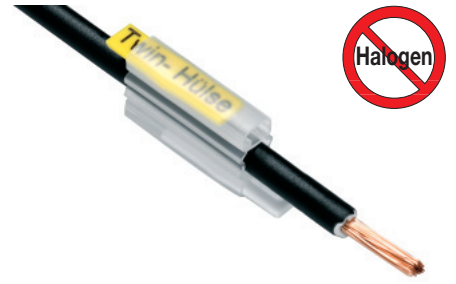

Twin sleeves provide a two-side marking option of wires. They can be fitted with two TM-I 18 tags, so that input and output designations of a wire can be viewed from a single vantage point. The transparent, halogen-free sleeves can be used for external wire-insulation diameters from 1.3 to 4.0 mm.

**Technical data**

Material	Polyethylene PE-LD
Flammability class to UL 94	HB
Temperature range	-20 ... + 80 °C
Dimensions	Length: 18 mm
Colour	Transparent
Possible marking systems	Insert tag TM-I 18
Minimum order quantity	1 Qty.

**Ordering information**

Type	Insulation, ext. Ø	Cond. cross-sec.
TM 0/18 Twin HF/HB	1.3 – 2.6 mm	0.22 – 1.5 mm <sup>2</sup>
TM 1/18 Twin HF/HB	2.4 – 4.0 mm	1.0 – 2.5 mm <sup>2</sup>

**Ordering data**

Type	Qty.	Order No.
TM 0/18 Twin HF/HB	500	1891810000
TM 1/18 Twin HF/HB	500	1891780000

**WPT sleeve**

**Transparent sleeves**



WPT wire and cable markers are high-quality, transparent markers available in various lengths for marking cables with cross-sections from 0.22 mm<sup>2</sup> to maximum 75 mm<sup>2</sup>.

- Wider cross-section range per sleeve
- Wider application range thanks to special resilient bellow profile
- Marker tag inserts easily into marker pocket before and after wire is connected
- Available in five lengths and four sizes

**Technical data**

Material	Soft PVC, cadmium- and silicone-free
Temperature range	-30 °C to +80 °C
Flammability class.	Flame resistant and self-extinguishing, V0 to UL94
Resistance	Highly resistant to oils and petrol as well as gamma and UV radiation
Print	Insert tag TM-I for WPT and WPM 10-33

**Ordering information**

Type	Insulation, ext. Ø	Cond. cross-sec.
WPT 02	1.3 – 3.0 mm	0.22 – 1.5 mm <sup>2</sup>
WPT 1	2.5 – 5.0 mm	0.75 – 6.0 mm <sup>2</sup>
WPT 2	4.0 – 10.0 mm	4.0 – 35.0 mm <sup>2</sup>
WPT 3	8.0 – 16.0 mm	6.0 – 75.0 mm <sup>2</sup>

**Ordering data**

Type	Length / Width [mm]	Qty.	Order No.
WPT 02-12		200	1764060000
WPT 02-15		200	1764070000
WPT 02-18		200	1764140000
WPT 02-20		200	1764150000
WPT 02-30		200	1889580000
WPT 1-12		200	1764190000
WPT 1-15		200	1764200000
WPT 1-18		200	1764210000
WPT 1-20		200	1764220000
WPT 1-30		200	1889560000
WPT 2-12		100	1764230000
WPT 2-15		100	1764240000
WPT 2-18		100	1764250000
WPT 2-20		100	1764260000
WPT 2-30		100	1889570000
WPT 3-12		100	1764270000
WPT 3-15		100	1764280000
WPT 3-18		100	1764290000
WPT 3-20		100	1764300000
WPT 3-30		100	1889550000

**WPM sleeve**

**Transparent sleeves**



WPM is the right sleeve for larger wire cross-sections. The transparent sleeve pocket protects the insert tags against environmental conditions. The transparent WPM sleeves are securely attached using cable ties. TM-I 18 for WPM 10/33 or ESG 9/17 for WPM 20/33 provide the markings. Both insert tags have been designed in the proven Multicard format for convenient printing with SMark-Laser, PrintJet, Plotter or MC-Mobilo. The tag PF 2/17.5 is suitable for the WPM 20/66.

- Secure attachment with cable ties
- Professional printing assured thanks to Weidmüller's printing system for MultiCards

**Technical data**

Material	PVC
Flammability class to UL 94	V0
Temperature range	-30 ... +60 °C
WPM 20 dimensions	Length: 33 mm and 66 mm Width: 11.3 mm
WPM 10 dimensions	Length: 33 mm Width: 6 mm
Colour	transparent
Possible marking systems	Insert tags TM-I 18 ESG 9/17 or PF2/17,5

**Ordering data**

Type	Qty.	Order No.
WPM 10/33	100	1763270000
WPM 20/33	100	1763280000
WPM 20/66	50	1763390000
<b>Accessories</b>		
ESG 9/17 neutral	200	1724760000
ESG 9/17 printed	200	1770480000
WPF 2/17.5	DIN A 4 sheets = 352 Labels	1764050000

**WKM sleeve**

**Transparent sleeves**

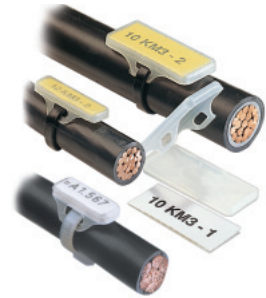

Providing secure attachment to the wire or cable, WKM is the right marker for tough conditions. The transparent sleeve pocket guarantees reliable protection of the marking in tough environmental conditions. Cable tie attachment facilitates their use with practically all wire cross-sections. WKM provides numerous markings options, for example, laser print, matrix print or STI marking pen on paper or polyester labels.

**Technical data**

<b>Tag carriers</b>	
Material	Polypropylene
Flammability class to UL94	IP40
Temperature range °C	-40...80
Colour	transparent

**Ordering data**

Type	Length / Width [mm]	Qty.	Order No.
WKM 18/43	43/18	50	1610700000
WKM 8/20	20/8	50	1753490000
WKM 8/30	30/8	50	1631910000

**Accessories**

Type	Length / Width [mm]	Qty.	Order No.
ESG 7/20 white	7/20	200	1736181044
ESO 5 white	40/16.5	1	1607710000
ESO 5 yellow	40/16.5	1	1631350000
ESO 5P white	40/16.5	10	1670370000
ESO 5P yellow	40/16.5	10	1670380000
ESO 7 white	27/6.3	1	1607720000
ESO 7 yellow	27/6.3	1	1634780000
ESO 7P white	27/6.3	10	1670390000
ESO 7P yellow	27/6.3	10	1670400000

ESO 5/5P: 16.5 x 40 mm, 60 tags per sheet  
ESO 7/7P: 6.3 x 27 mm, 240 tags per sheet

**WPF sleeve**

**Insert tags**



**TM-I**

**Insert tags**

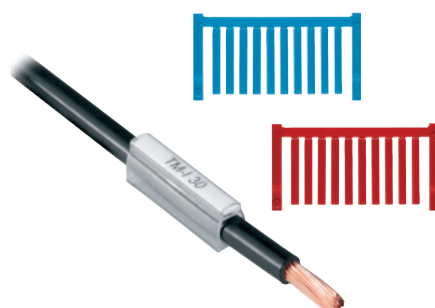

WPF insert tags are made from a halogen-free polyester material. The perforated edges ensure the tags can easily be separated from the A4 sheets in which they are supplied. The pre-print treated material guarantees rapid and permanent marking by means of laser, matrix or plotter print.

Easy to fit and secure attachment thanks to the special contour of the TM-I. They are compatible with numerous commercially available sleeves. The MultiCard format means that the tags can be rapidly and easily printed with the printing systems SMark-Laser, PrintJet, Plotter, MC-Mobilo or the STI pen. Thanks to the project marker surface of the MultiCard, they can easily be separated and then attached.

There are five marker lengths available for custom prints with long sequences of characters.

- Project marker surface for easy separation and attachment
- Approved and listed markers for traffic engineering
- Top flexibility through advanced attachment of sleeve and retrospective fitting of tags

**Technical data**

Material	polyester foil, halogen-free
Temperature range	-30 to + 120 °C
Dimensions	
WPF 1/21	21 mm
WPF 2/17,5	17.5 mm
Colour	white, yellow
Possible printing systems	Laser printer, Matrix printer, Plotter
Verwendbare Hülsen	WPT, WPM

**Technical data**

Material	Polyamide, halogen-free
Flammability class to UL 94	V2
Temperature range	-40°C to + 100°C
Dimensions	12 x 4, 15 x 4, 18 x 4, 20 x 4, 30 x 4 mm
Colour	white, yellow, red, blue, green
Possible printing systems	Plotter, SMark-Laser, PrintJet, MC-Mobilo
Wipe resistance	In accordance with IEC 50
Order software	<b>M-Comm2</b>
For custom print	(Order No. <b>1753350000</b> )

**Ordering data**

**WPF**

Type	Order No.
WPF 1/21 white	<b>1600741044</b>
WPF 1/21 yellow	<b>1600741687</b>
WPF 2/17,5 white sheets	<b>1764050000</b>

**Ordering data**

**TM-I**

Type ( length)	Colour	Qty.	Order No.
TM-I 12 MC NEUTRAL WS	white	320	<b>1718411044</b>
TM-I 12 MC NEUTRAL RT	red	320	<b>1718411686</b>
TM-I 12 MC NEUTRAL GE	yellow	320	<b>1718411687</b>
TM-I 12 MC NEUTRAL GN	green	320	<b>1718411688</b>
TM-I 12 MC NEUTRAL BL	blue	320	<b>1718411693</b>
TM-I 15 MC NEUTRAL WS	white	400	<b>1609981044</b>
TM-I 15 MC NEUTRAL RT	red	400	<b>1609981686</b>
TM-I 15 MC NEUTRAL GE	yellow	400	<b>1609981687</b>
TM-I 15 MC NEUTRAL GN	green	400	<b>1609981688</b>
TM-I 15 MC NEUTRAL BL	blue	400	<b>1609981693</b>
TM-I 18 MC NEUTRAL WS	white	320	<b>1718431044</b>
TM-I 18 MC NEUTRAL RT	red	320	<b>1718431686</b>
TM-I 18 MC NEUTRAL GE	yellow	320	<b>1718431687</b>
TM-I 18 MC NEUTRAL GN	green	320	<b>1718431688</b>
TM-I 18 MC NEUTRAL BL	blue	320	<b>1718431693</b>

**Ordering data**

**TM-I**

Type (length)	Colour	Qty.	Order No.
TM-I 20 MC NEUTRAL WS	white	400	<b>1680411044</b>
TM-I 20 MC NEUTRAL RT	red	400	<b>1680411686</b>
TM-I 20 MC NEUTRAL GE	yellow	400	<b>1680411687</b>
TM-I 20 MC NEUTRAL GN	green	400	<b>1680411688</b>
TM-I 20 MC NEUTRAL BL	blue	400	<b>1680411693</b>
TM-I 30 MC NEUTRAL WS	white	300	<b>1876390000</b>
TM-I 30 MC NEUTRAL RT	red	300	<b>1876380000</b>
TM-I 30 MC NEUTRAL GE	yellow	300	<b>1876370000</b>
TM-I 30 MC NEUTRAL BL	blue	300	<b>1876400000</b>
<b>Custom print</b>			
TM-I 12 MC CUSTOM PRINT		64	<b>1718420000</b>
TM-I 15 MC CUSTOM PRINT		80	<b>1609990000</b>
TM-I 18 MC CUSTOM PRINT		64	<b>1718440000</b>
TM-I 20 MC CUSTOM PRINT		80	<b>1680420000</b>
TM-I 30 MC CUSTOM PRINT		60	<b>1876320000</b>

# Markers for devices and installations

Device and installation markers round off the range of switchgear markers. By utilising Weidmüller's device markers, users comply with official regulations requiring marking of electrical equipment. Weidmüller offers corresponding markers for devices made by well-known manufacturers. Mirroring their original counterparts, these tags are available with the classic adhesive or rapid clip-on attaching techniques. By utilising the corresponding software and system-compatible printer or plotter system, users can print their own markings on the device markers.

Weidmüller also offers ready-to-use printed labels in the form of a Symbol Packs or Service Packs.

A samples bag containing a selection of device and installation markers is available under the order no. **1646370000**.

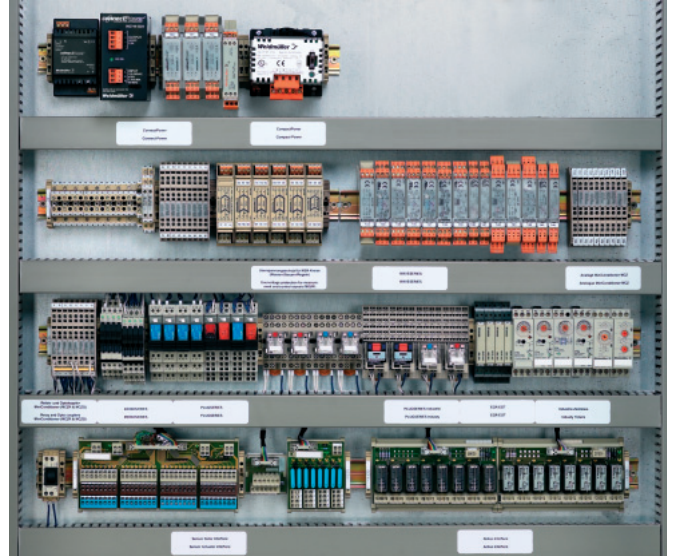

### SwitchMark

### ESG

### ClipCard



	SwitchMark	ESG	ClipCard
Cable ducts			●
Automatic switchgear	●	●	●
Contactors	●	●	
Electrical connections			●
Electrical devices			●
Machines			
LED displays	●		
Keyboards	●		
Lamps			●
Murr valve plug		●	
Tubes			●
Circuit-breakers		●	
Relays		●	
Maintenance			
Shelves			
Switches	●	●	●
Control desk	●	●	●
Transformers		●	
Valves			●

## ESG tag

ESG is the proven marker in MultiCard format for many well-known electrical devices. The result is high-quality device markings with a contrast-rich appearance.

We offer versions for the devices produced by the following manufacturers:

- ABB
- Siemens
- Moeller
- Télémécanique
- For universal use, self-adhesive or clip-on tags are available (depending on the type)

ESG for clipping onto tag rails; suitable for devices mounted in rows, such as miniature circuit-breakers.

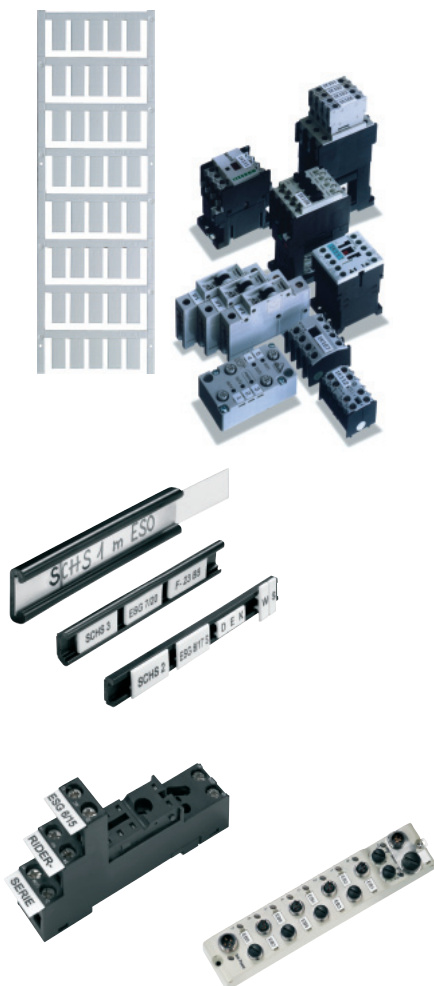

## Technical data

Colour	White, yellow (turquoise, ESG 7/20 only)
Wipe resistant	In accordance with DIN IEC 50
Adhesive force on stainless steel	K = normal adhesive 22 N/m
Material	Polyamide, halogen-free
Flammability class to UL 94	V2
Temperature range	-40 °C ... +100 °C
Possible printing systems	PrintJet, Plotter, SMark-Laser, MC-Mobilo

## Ordering data

Type neutral	Application	W / L	Qty.	Order No.
ESG 6/15 K MC NEUTR. GE	Self-adhesive	6 x 15	200	1880130000
ESG 6/15 K MC NEUTR. WS	Self-adhesive	6 x 15	200	1880100000
ESG 6/15 MC RIDERSERIES	Riderserie SCM/SRC	6 x 15	200	1881280000
ESG 6/17 K MC NEUTR. GE	Self-adhesive	6 x 17	200	1880110000
ESG 6/17 K MC NEUTR. WS	Self-adhesive	6 x 17	200	1880120000
ESG 7/20 SIRIUS GE	Siemens Sirius 3R / tag rail 3 u. 4	7 x 20	200	1736181687
ESG 7/20 SIRIUS TURQUOISE	Siemens Sirius 3R	7 x 20	200	1736181696
ESG 7/20 SIRIUS WS	Siemens Sirius 3R	7 x 20	200	1736181044
ESG 8/10 ASI	Siemens AS-interface	8 x 10	200	1736190000
ESG 8/17 MC NEUTRAL	Télémécanique	8 x 17	200	1674740000
ESG 8/17 SYS PRO M	GE power Controlls (AEG); ABB-Stotz	8 x 17	200	1755340000
ESG 8/17 SCHS MC NEUTR.	Tag rail SchS2	8 x 17	200	1720610000
ESG 8/17 L MC NEUTRAL	Lumberg distributor	8 x 17	200	1890470000
ESG 8/19 MC NEUTRAL	AEG	8 x 19	200	1652220000
ESG 9/10 MC neutral WS		9 x 10	200	1775910000
ESG 9/11K MC Neutral	Self-adhesive	9 x 11	200	1857440000
ESG 9/17 MC NEUTRAL	Insert tag	9 x 17	200	1724760000
ESG 9/17 K NEUTRAL/GE	Self-adhesive	9 x 17	200	1753500000
ESG 9/17 K NEUTRAL/WS	Self-adhesive	9 x 17	200	1674760000
ESG 10/17 MC Neutral	Allen Bradley / Festo MT	10 x 17	200	1856700000
ESG 9/20 L MC NEUTRAL	Lumberg distributor	9 x 20	200	1890460000
ESG 9/20 MC neutral, without foot	Insert tag for TMC sleeve	9 x 20	200	1770500000
ESG 9/20 MC NEUTRAL GE	Siemens + Moeller+WI SAI distributor	9 x 20	200	1766160000
ESG 9/20 MC NEUTRAL WS	Siemens + Moeller+WI SAI distributor	9 x 20	200	1609940000
ESG 9/20 MC Universal	Siemens + Moeller+WI and Murr SAI distributor + Festo CPV/CPI	9 x 20	200	1856720000

Tag rail			Order No.
Tag rail SchS1	for ESO with protective strip	Length 1 m	0138900000
Tag rail SchS2	for ESG 18/17 S ; DEK ; WS	Length 1 m	0337400000
Tag rail SchS2, self-adhesive	for ESG 18/17 S ; DEK ; WS	Length 1 m	1720600000
Tag rail SchS3 white, self-adhesive	for ESG 7/20	Length 1 m	1753480000
Tag rail SchS4 grey, self-adhesive	for ESG 7/20	Length 1 m	1753460000
ESO/SCHS1 500X12,5X0,3	Insert strips for SCHS1	Length 0.5 m	0139000000
STR SCHS1	Protective strip for SCHS1	Length 0.5 m	0139200000

Type custom print	Colour and print details	Qty.	Order No.	
ESG 6/15 K		6 x 15	40	1880090000
ESG 6/15 RIDERSERIE		6 x 15	40	1881290000
ESG 6/17 K		6 x 17	40	1880080000
ESG 7/20 SIRIUS		7 x 20	40	1766650000
ESG 8/10 ASI		8 x 10	40	1770470000
ESG 8/17		8 x 17	40	1674750000
ESG 8/17 SYS PRO M		8 x 17	40	1755350000
ESG 8/17 SCHS		8 x 17	40	1766640000
ESG 8/19 MC		8 x 19	40	1652230000
ESG 9/11 K		9 x 11	40	1857450000
ESG 9/17		9 x 17	40	1770480000
ESG 9/17 K		9 x 17	40	1674770000
ESG 10/17		10 x 17	40	1856710000
ESG 9/20, without foot		9 x 20	40	1770510000
ESG 9/20		9 x 20	40	1609950000
ESG 9/20 MC Universal		9 x 20	40	1856730000

SwitchMark SM

SwitchMark (SM) markers are used to identify command and signalling devices. The tags are either snapped into the holder or secured by means of the self-adhesive foil on their rear. Individual custom prints can be created using the printing system SMark-Laser, PrintJet, Plotter or MC-Mobilo.

- Create individual custom prints utilising Weidmüller's marking system for MultiCards.
- Fast production of custom prints to in-house specifications.
- No need to store expensive standard tags.
- Extremely resistant print quality with PrintJet instead of engraving.
- We recommend the protective foil ETO SM for extreme conditions.

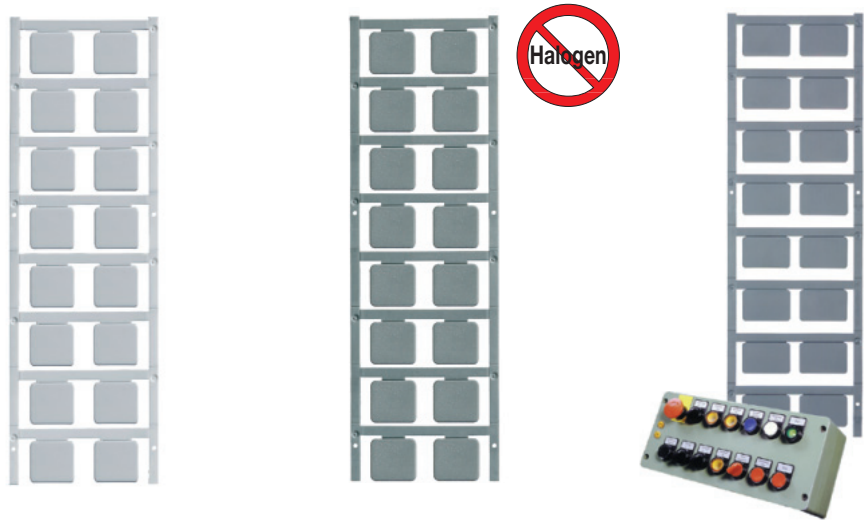

Technical data

Material	Polyamide 66, halogen-free
Flammability class to UL94	V2
Temperature range °C	-40...100

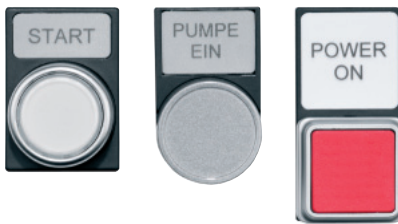

SwitchMark Neutral

Type	Length (mm)	Width (mm)	Qty.	Order No.
				white
				silver
SM 27/8	8	27	80	1699820000
SM 27/12,5	12.5	27	80	1699840000
SM 27/18	18	27	80	1699860000
SM 27/27	27	27	60	1773220000

SwitchMark neutral, self-adhesive

Type	Length (mm)	Width (mm)	Qty.	Order No.
				white
				silver
SM 27/8 K	8	27	80	1812630000
SM 27/12,5 K	12.5	27	80	1699880000
SM 27/18 K	18	27	80	1707270000
SM 22/22 K	22	27	80	1877570000
SM 27/27 K	27	27	60	1783000000

SwitchMark custom print

Type	Length (mm)	Width (mm)	Qty.	Order No.
				Colour and print details
SM 27/8	8	27	80	1699830000
SM 27/8 K	8	27	80	1713690000
SM 27/12,5	12.5	27	80	1699850000
SM 27/12,5 K	12.5	27	80	1699890000
SM 27/18	18	27	80	1699870000
SM 27/18 K	18	27	80	1707280000
SM 22/22 K	22	27	80	1877580000
SM 27/27	27	27	60	1773240000
SM 27/27 K	27	27	60	1783010000

## ClipCard

ClipCard device markers in MultiCard format offer an interesting alternative to **engraving**. This assortment is used to mark electrical installations and switchgear. The proven MultiCard format means it is possible to print with any of the SMark-Laser, PrintJet, Plotter and MC-Mobilo printers.

- Extremely resilient print quality with PrintJet instead of engraving
- Universal attachment
  - Holder (screw attachment or with cable tie)
  - Tag rail (self-adhesive and screw attachment)
  - or self-adhesive markers
- For extreme conditions, we recommend:
  - Protective strips (holder)
  - Protective rail (CC-Rail)
  - Protective foil for markers (see page 38)

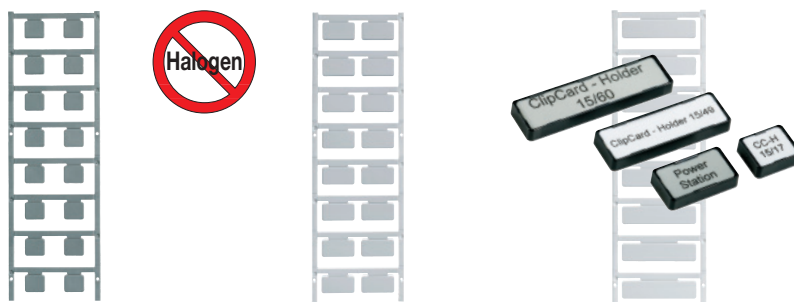

### Technical data

Material	Polyamide 66, halogen-free
Flammability class to UL94	V2
Temperature range °C	-40...100

### ClipCard neutral

Type	Length (mm)	Width (mm)	Qty.	Order No.	white	silver
CC 15/17 MC	17	15	80	1876570000		1876610000
CC 15/27 MC	27	15	80	1876770000		1876760000
CC 15/49 MC	49	15	40	1877260000		1877240000
CC 15/60 MC	60	15	40	1877350000		1877340000

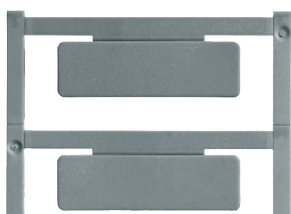

### ClipCard neutral, self-adhesive

Type	Length (mm)	Width (mm)	Qty.	Order No.	white	silver
CC 15/17 K MC	17	15	80	1876590000		1876580000
CC 15/27 K MC	27	15	80	1876640000		1876780000
CC 15/49 K MC	49	15	40	1877220000		1877270000
CC 15/60 K MC	60	15	40	1877310000		1877360000



### Custom print

Type	Length (mm)	Width (mm)	Qty.	Order No.	Colour and print details
CC 15/17 MC	17	15	16	1876620000	
CC 15/17 K MC	17	15	16	1876600000	
CC 15/27 MC	27	15	16	1876630000	
CC 15/27 K MC	27	15	16	1876750000	
CC 15/49 MC	49	15	8	1877200000	
CC 15/49 K MC	49	15	8	1877230000	
CC 15/60 MC	60	15	8	1877300000	
CC 15/60 K MC	60	15	8	1877320000	

**SwitchMark SM**

**Accessories**



The device and installation markers are either snapped into the holder or secured by means of the self-adhesive foil on their rear.

- For example: insert the SM 27/18 into the holder that we offer as well as the markers
- We recommend that the transparent protective foil ETO SM be used if the print is subjected to extreme demands with respect to their wipe and scratch resistance in the presence of chemicals

**Ordering data SwitchMark SM**

Type	Qty.*	Order No.
<b>Holder, black</b>		
SM-H 27/12,5	25	1716640000
SM-H 27/18	25	1716630000
SM-H 27/27	20	1782710000
<b>Protective foil</b>		
ETO SM 27/8	1 (165)	1720570000
ETO SM 27/12,5	1 (100)	1720580000
ETO SM 27/18	1 (112)	1720590002
ETO SM 22/22	1 (112)	1880720000
ETO SM 27/27	1 (70)	1805840000
* Details in round brackets indicate the number of markers per sheet		

**ClipCard CC**

**Accessories**



Universal attachment options with the possibility of being mounted either in a holder, per cable tie or screw as well as by utilising CC-Rail tag rails.

- Universal attachment options: per holder, cable tie or screw as well as by means of a tag rail
- For extreme conditions, we recommend:
  - Protective strips (holder)
  - Protective rail (CC-Rail)
  - Protective foil for markers (see page 38)

**Ordering data ClipCard CC**

Type	Qty.*	Order No.
<b>Holder</b>		
CC-H 15/17	75	1790430000
CC-H 15/27	45	1790410000
CC-H 15/49	25	1790420000
CC-H 15/60	25	1878910000
<b>Protective strips</b>		
STR CC 15/17	80	1888310000
STR CC 15/27	80	1888290000
STR CC 15/49	40	1888300000
STR CC 15/60	40	1888280000
<b>Protective foil</b>		
ETO CC 15/17	1 (228)	1880850000
ETO CC 15/27	1 (133)	1880810000
ETO CC 15/49	1 (76)	1880830000
ETO CC 15/60	1 (57)	1880840000
<b>Tag rails</b>		
CC-Rail 1000	1	1790150000
CC-Rail 1000 transparent	1	1790160000
* Details in round brackets indicate the number of markers per sheet		



# Overview of printers and software

Weidmüller's printing systems allow you to print your terminal markers, wire and cable markers as well as your device markers – fast and reliably. The **M-Print PRO** software offers top of the range data conversion routines. Data integration progresses to being a means for work organisation when additional contract data is also added to the pure data for markings – meaning the project, customer or the arrangement.

**M-Print PRO** offers true user-friendly operation under Windows.

Weidmüller's printers **PrintJet**, **SMark-Laser printer** or **MC-Mobilo** are available for printing out jobs. PrintJet is the best example of clear-cut printing quality. SMark-Laser printers are distinguished by their speed and the resilience of their prints. As well as the ease with which they can be installed, project assignment details on project marker surfaces are a further highlight of printed MultiCards.



SMark-Laser



PrintJet



MC-Mobilo

Markers	Software <sup>3</sup>	Printers		
	M-Print PRO	SMark-Laser	PrintJet	MC-Mobilo
<b>Terminal markers</b>				
DEK	●	●	●	●
WS	●	●	●	● <sup>1</sup>
ZS	●	●	●	●
MF	●	●	●	●
GWS	●	●	●	●
<b>Wire markers</b>				
SF	●	●	●	● <sup>2</sup>
SFX	●	●	●	●
SFC	●	●	●	●
TM-I	●	●	●	●
WKS	●			
<b>Device markers</b>				
ESG	●	●	●	●
SM	●	●	●	●
ClipCard	●			

<sup>1</sup> Sußer WS 15/5.

<sup>2</sup> SF 4, 5 and 6 with corresponding support frame only

<sup>3</sup> Three demonstration versions of our software are available from our homepage [www.weidmueller.de](http://www.weidmueller.de)

## PrintJet II

The **PrintJet printer** allows you to print customised marker prints for terminal blocks, switchgear, cables, wires and circuit-breakers at your convenience.

- Sharp print contours
- High-contrast typeface
- Extremely resilient lettering
- Permanently readable identification
- Fast and user friendly
- Compatible with all MultiCards
- The PrintJet-Loader holds up to 20 MultiCards

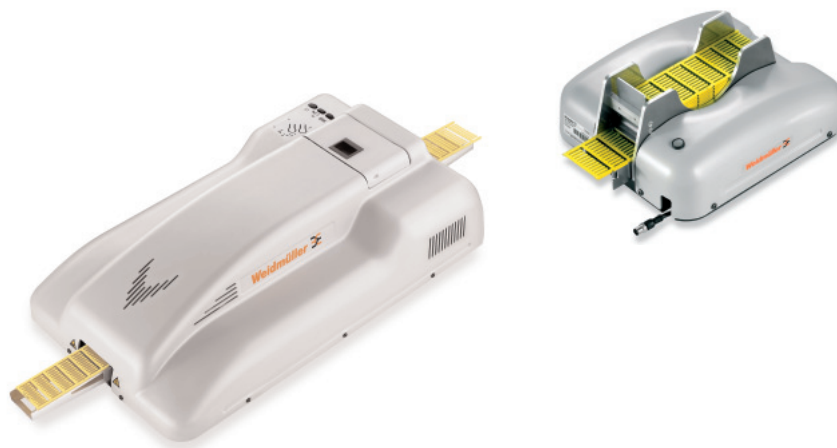

### Technical data

Type	PrintJet II
Application	Prints MultiCard markers
Technology	Ink-jet process
Print quality	2880 dpi
Printer drivers	Win 9X, Win NT, Windows 2000
Print software	Recommended: M-Print 1.60
System requirements	Windows 95/98/NT/2000/XP
Feed	Manual or with optional loader
Fusing	Thermal fusing
Interface	Centronics and USB
Connection	AC 230 V/AC 115 V
Location	Office conditions
Ambient temperature	20 °C – 35 °C
Dimensions (L x W x H)	800 x 450 x 200 mm
Cartridge system	Ink cartridge, black (210 000 characters, Arial font size 6); average print performance per day: 20 MultiCards; max. print performance per day: 100 MultiCards
Range of supply	PrintJet printer, power cable, printer drivers, manuals (CD), cleaning unit, Centronics cable, software M-Print

#### PrintJet-Loader

System requirements	PrintJet printer
Marker types	MultiCard format
Operating voltage	12 V/DC
Current input	approx. 1 A
Interface	Connection via plug-in connector
Location	Office conditions
Ambient temperature	20 °C – 35 °C
Dimensions (L x W x H)	345 x 305 x 155 mm
Weight	4 kg

### Ordering data

Type	Order No.
PrintJet II 115 V	1858980000
PrintJet II 230 V	1858990000
PrintJet-Loader	1813090000
<b>Accessories</b>	
Ink cartridge PrintJet II	1858920000
Clean Unit PrintJet II	1858950000
Ink cartridge PrintJet	1797460000
Clean Unit PrintJet	4062150000

### PrintJet II

## SMark-Laser

The SMark-Laser has brought speed to the world of markings.

- Fast printing speed
- 4 MultiCards per minute
- Top print quality
- Markers immediately ready for use
- Works fast, independent of the amount of data
- Extreme flexibility through production of markers in MultiCard format to suit your needs
- Reduced storage, because only neutral markers are required
- Suitable for graphics
- Compatible with all standard operating systems (for example, WIN 3x, WIN 9x, OS/2, NT, WIN 2000, XP)
- Standard software compatible
- Optional automatic feed for larger jobs
- Replaceable toner cartridge with handle
- Compatible with Weidmüller software 'M-Print', order no.: **1784560000**.



### Technical data

Type	SMark-Laser
Application	Prints all MultiCards
Technology	Laser printer
Printing speed	4 MultiCards per minute
Print quality	600 dpi
Printer drivers	WIN3.x, 9x, NT, HP III compatible
Software	M-Print settings, commercially-available standard software
System requirements	Windows 95/98/NT/2000/XP
Feed	Manual or with optional loader
Interfaces	Centronics optional, Apple Talk
Supply voltage	AC 230 V / 50 Hz / 16 A
Ambient conditions	20 °C – 35 °C
Dimensions: (L x W x H)	1000 x 430 x 380 mm
Range of supply	Laser printer, power cable, printer drivers, manual, interface cable, M-Print software

### Ordering data

### SMark-Laser

Type	Order No.
SMark-Laser	1767090000
Rack	1782880000
Special toner cartridge	1770070000

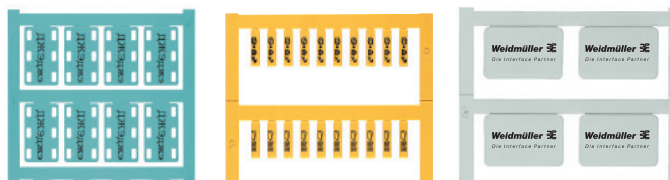

### Print options

## Printers

### Accessories for Plotter IP-220 Standard

### STI-S

### MC-Mobilo

STI-S pen with adapter



Plotter pen



Adapter for STI-S



INK 2000 drawing ink and  
CLEAN 2000 cleaner



for marking:

- MultiCards
- WS strips, Dekafix cards (inlay required)
- PA 02, PA1, PK 2/25, PK 2/40 (inlay required)
- LogiMark, WKS, E-Fix, VarioCut (cutting option required)
- SlimFix 1, 2, 3 and SFX (not SlimFix 4 and 5)

The STI-S fibre pen is ideal for marking neutral Weidmüller marker products. It is suitable for marking manually or in conjunction with the STI-S adapter for plotter printing. Black, water-resistant ink is used.

MC-Mobilo is the key to printing without a computer or mains supply. Users are able to work in the field with the MC-Mobilo, without the need for an established workstation. Once charged, the battery will last for approx. 3 hours. Utilising the universal inlay allows practically all MC MultiCards to be processed.

#### Ordering data

#### Plotter IP-220

Type	Order No.
MC Wago/Phoenix adapter plates	<b>1754980000</b>
Murr/Wago adapter plates (Roland 5 MC'S 1150 A)	<b>1754990000</b>
Murr plastic adapter plates (Roland 4 MC'S 1150)	<b>1755030000</b>

#### Ordering data

#### Pen/adapter

Type	Order No.
Plotter pen 0.18	<b>1768570000</b>
Plotter pen 0.25	<b>1768540000</b>
Plotter pen 0.35	<b>1768550000</b>
Plotter pen 0.5	<b>1768560000</b>
Plotter adapter (without nib)	<b>1684480000</b>
Plotter nib BTS 0.25 mm	<b>1603360000</b>
Plotter nib BTS 0.35 mm	<b>1603370000</b>
Plotter nib BTS 0.50 mm	<b>1603380000</b>
Trial installation/instruction IP 220 (within Germany only)	<b>1546800000</b>
Adapter for STI-S	<b>1762440000</b>
STI-S pen	<b>0508401694</b>
<b>Ink and cleaner</b>	
Ink 2000 drawing ink	<b>1772120000</b>
Clean 2000 cleaner	<b>1772130000</b>
Permanent fibre pen set (5 items, partially non-fading, <b>for labels only</b> )	<b>1730470000</b>
Print kit consisting of Ink 2000, Clean 2000 cleaner and BTS 0.25 + adapter	<b>1686920000</b>

#### Ordering data

#### MC-Mobilo

Type	Order No.
MC-Mobilo basic device* 230 V Includes MC configuration, battery pack and charger in a portable case (German, English, French)	<b>1741260001</b>
MC-Mobilo basic device* 110 V Includes MC configuration, battery pack and charger in a portable case (German, English, French)	<b>1741260002</b>
Including universal inlay for all MC and SF cards up to size 3 with interfaces (9-pole) + software	

\* Please indicate required model (USA, GB, Europe)

# M-Print® PRO Label Designer

**Print and ordering software** for markers and labels

M-Print® PRO is a professional software for printing and ordering Weidmüller markers and labels under Windows®. This software helps you to optimise your processes for marking electrical equipment. You can design, print and order your marking material effortlessly, professionally and quickly: texts, frames, lines, graphics, barcodes, serial numbers and photos.

## Here is an overview of the main functions:

- Integrated product catalogue for all labels and markers, including images and links to the relevant web pages and product data sheets
- Markers and labels can be designed in as many levels as required
- Custom formatting of individual text characters (RTF)
- Perform copy-and-paste functions with texts and their formats
- Supports UNICODE for foreign-language texts, such as Russian, Chinese, Polish, ect.
- Enter data in labels and table sheet
- Permanent print preview: see how the printout will look during design phase
- Alphanumeric counts and sequences
- Extensive range of image formats (\*.bmp, \*.wmf, \*.png, \*.ico, \*.jpeg, \*.tif, \*.gif)
- Image library including all of the important symbols used in electrical engineering
- Assign product to specific printer; for example, ESG 9/20 to PrintJet, LaserMark to laser printer, ect.
- Supported output devices: PrintJet I+II, SMark-Laser, ThermoCard, THM as well as standard printers with Windows drivers
- Optimum and rapid adjustment of the output devices
- Online update service via Internet
- Interface to RailDesigner®
- Import assistant to create your own import filter for numerous file formats (\*.txt, \*.asc, \*.mak, \*.wei, \*.tmf, ect.)
- Integrates data from CAE systems

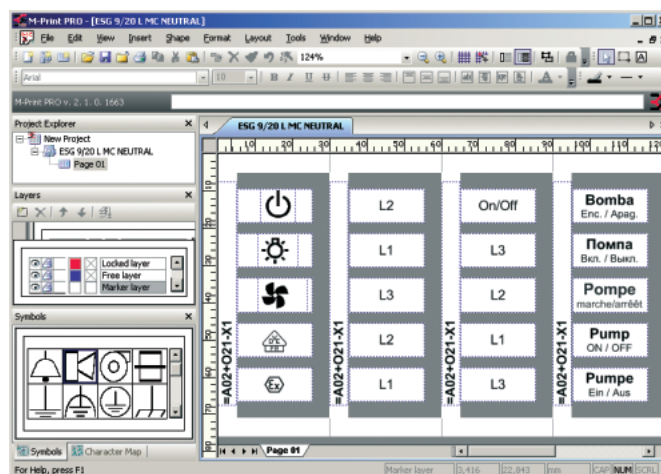

## Supported operating systems:

WINDOWS® 98 SE, ME, NT, 2000, XP, Server 2003

## System requirements:

- RAM: > 64 MB
- Processor: > Pentium PIII or comparable model
- Graphic: > 800 x 600 pixels with 256 colours  
optimum: 1024 x 768 with 16-bit High Colour
- Hard disk: > 90 MB free storage
- Miscellaneous: mouse, keyboard, CD-ROM drive (to install the software)

M-Print® PRO is available in two editions:

M-Print® PRO Standard Edition for professional printing results with all of Weidmüller's marking materials

M-Print® PRO Advanced Edition for professional printing results with all of Weidmüller's marking materials and customer specific labels

## Ordering data

## M-Print® PRO

Type	Order No.
M-Print® PRO	1905490000
M-Print® PRO advanced	1905500000

# Cable ties

## Cable ties

Cable ties keep things tidy in numerous fields of installations. Distinguishing features include an immense tying force plus a long service life. In addition, steel cable ties offer extremely durable attachment options that are capable of withstanding extreme material stresses caused by high temperatures or the powerful effects of chemicals.

### CB

CB cable ties provide secure attachment options for cables and markings. They are particularly suitable for attaching PK, SFX, WKM and WKS cable markers. The material is composed of unbreakable polyamide PA 6.6 with flammability class V2 to UL94.

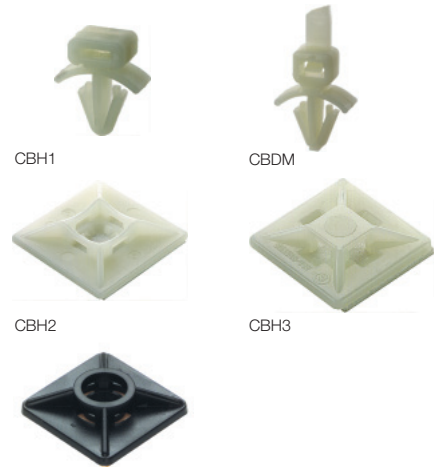

### Technical data

Material	Polyamide	
Flammability class to UL94	V2	
Dimensions	Length (mm)	Width (mm)
CB 750/7.8	750	7.8
CB 365/7.8	365	7.8
CB 360/4.8	360	4.8
CB 290/4.8	290	4.8
CB 290/3.6	290	3.6
CB 200/4.8	200	4.8
CB 200/3.6	200	3.6
CB 178/4.8	178	4.8
CB 160/4.5	160	4.5
CB 140/3.6	140	3.6
CB 98/2.5	95	2.5

### Technical data

Material	Polyamide
Flammability class	V2 to UL 94
CBDM	Cable ties for direct installation of cable harness max. ø: 44.5 mm Total length: 200 mm
CBH 1	Cable tie retainer for use on mounting plate Max. plate thickness 3.2 mm Hole ø max. 6.2 mm
CBH 2	Cable tie retainer for sticking to surface: 19 x 19 mm
CBH 3	Cable tie retainer for sticking to surface: 27 x 27 mm

### Ordering data

### CB

Type	Colour	Qty.	Order No.
CB 750/7.8	natural	100	1720680000
CB 750/7.8	black	100	1720670000
CB 365/7.8	natural	100	1279100000
CB 365/7.8	black	100	1697940000
CB 360/4.8	natural	100	1279000000
CB 360/4.8	black	100	1697930000
CB 290/4.8	natural	100	1278900000
CB 290/4.8	black	100	1697920000
CB 290/3.6	natural	100	1720640000
CB 290/3.6	black	100	1720650000
CB 200/4.8	natural	100	1278800000
CB 200/4.8	black	100	1697910000
CB 200/3.6	natural	100	1720630000
CB 200/3.6	black	100	1720660000
CB 170/4.8	natural	100	1723550000
CB 170/4.8	black	100	1723570000
CB 160/4.5	natural	100	1723540000
CB 160/4.5	black	100	1723560000
CB 140/3.6	natural	100	1278700000
CB 140/3.6	black	100	1697900000
CB 98/2.5	natural	100	1278600000
CB 98/2.5	black	100	1697890000

### Ordering data

### CBDM/CBH

Type	Colour	Qty.	Order No.
CBDM	natural	100	1279330000
CBH 1	natural	100	1279200000
CBH 2	natural	100	1289200000
CBH 3	natural	100	1289400000
CBH 2	black	100	1697950000
CBH 3	black	100	1697960000



# Worldwide activities

- A Austria**  
Weidmüller Ges.m.b.H.  
Industriezentrum Nö Süd  
Straße 2, Objekt M2  
2355 Wiener Neudorf  
Phone +43 2236 6708-0  
Fax +43 2236 6708-199  
office.at@weidmueller.com
- ADN Yemen**  
Please contact  
Weidmüller Middle East  
United Arab Emirates
- AUS Australia**  
Weidmüller Pty. Ltd.  
43 Huntingwood Drive  
Huntingwood,  
NSW, 2148  
P.O.Box 6944  
Blacktown  
NSW, 2148  
Phone +61 2 9671-9999  
Fax +61 2 9671-9911  
info@weidmuller.com.au  
www.weidmuller.com.au
- B Belgium**  
Weidmüller Benelux B.V.  
Ambachtenlaan 11 A  
3001 Heverlee  
Phone +32 16 395990  
Fax +32 16 401051  
info@weidmueller.be
- BA Bosnia-Herzegovina**  
BH ES Elektrosistem d.o.o.  
ul. J. Veselinovica 18  
78000 Banja Luka  
Bosna  
Phone +387 51 317500  
Fax +387 51 317500  
elsist@inecco.net  
www.elektrosistem.co.yu
- BG Bulgaria**  
Weid-Bul eOOD  
ul. Nezabavka 33 A,  
bl. 315/3/10  
1113 Sofia  
Phone +359 2 9632560  
Fax +359 2 9631098  
weidbul@nat.bg
- BR Brazil**  
Conexel Conexoes Elétricas Ltda.  
Rua Garcia Lorca, 176- V. Pauliceia,  
09695-900, Sao Bernardo do  
Campo - SP, Brasil  
Phone +55 11 43669600  
Fax +55 11 43621677  
vendas@conexel.com.br  
www.conexel.com.br
- BRN Bahrain**  
Khayber Trading Company  
P.O. Box 1976 Manama,  
Bahrain  
Phone +973 720 747  
Fax +973 720 331  
khayber@batelco.com.bh
- BY Belarus**  
TECHNIKON Ltd.  
Oktyabrskaya Str. 16/5  
Apt. 704  
220030 Minsk  
Belarus  
Tel. +375 17 2104626  
Fax +375 17 2275830  
technikon@belsonet.net
- CDN Canada**  
W Interconnections Canada Inc.  
10 Spy Court, Markham,  
Ontario L3 R5 H6  
Phone +1 905 475-1507  
Fax +1 905 475-5855  
info1@weidmuller.ca  
www.weidmuller.ca
- CH Switzerland**  
Weidmüller Schweiz AG  
Rundbuckstrasse 2  
8212 Neuhausen am Rheinfall  
Phone +41 52 6740707  
Fax +41 52 6740708  
mail:info@weidmueller.ch  
www.weidmueller.ch
- CN China**  
Weidmüller Interface International  
Trading (Shanghai) Co., Ltd.  
Unit 503-504 Central Plaza,  
No. 227 Huangpi N. Rd.,  
200003 Shanghai  
P.R. China  
Phone +86 21 63758766  
Fax +86 21 63759077  
www.cnweidmuller.com
- CO Columbia**  
Automatizacion Avanzada S. A.  
Carrera 97 No. 42 A-23 B3,  
Santafe de Bogotá Colombia.  
Phone +57 1 4132048  
Fax +57 1 4159788  
mgallegos@  
automatizacionavanzada.com
- CR Costa Rica**  
ELVATRON S.A.  
400 Norte  
Banco Costa Rica, la Uruca,  
San José, Costa Rica  
Phone +506 2 961060  
Fax +506 2 960328  
dirk.haase@elvatron.com
- CZ Czech Republic**  
Weidmüller s. r. o.  
Videnska ul. 340  
25242 Vestec u Prahy  
Phone +420 2 44001400  
Fax +420 2 44001499  
office@weidmueller.cz
- D Germany**  
Weidmüller GmbH & Co. KG  
Ohmstraße 9  
32758 Detmold  
Phone +49 5231 1428-0  
Fax +49 5231 1428-116  
weidmueller@weidmueller.de  
www.weidmueller.de
- DK Denmark**  
Knud Wexøe A/S  
Skaettekaeret 11  
P.O. Box 152  
2840 Holte  
Phone +45 45465800  
Fax +45 45465801  
wexoe@wexoe.dk
- E Spain**  
Weidmüller S. A.  
Narcis Monturiol 11-13  
Pol.Ind. Sudcoeste  
08960 Sant Just Desvern  
Barcelona  
Phone +34 93 4803386  
Fax +34 93 3718055  
weidmuller@weidmuller.es  
www.weidmuller.es
- ES El Salvador**  
Please contact  
ELVATRON S. A., Costa Rica
- EST Estonia**  
Alter Electric OÜ  
Turi 6, 11313 Tallinn, Estonia  
Phone +372 65 19 666  
Fax +372 65 19667  
alter@alter.ee
- ET Egypt**  
Standard Electric  
5, Heliopolis Hospital Street,  
Cairo, Egypt  
Phone +20 2 6444182  
Fax +20 2 6444191  
stdelec@click.com.eg
- F France**  
Weidmüller EURL  
12, Chaussée Jules César  
B.P. 263 Osny  
95523 CERGY PONTOISE Cedex  
Phone +33 1 34245500  
Fax +33 1 34245501  
mail@weidmuller.fr  
www.weidmuller.com
- FIN Finland**  
JUHA-ELEKTRO OY  
Kylvöpolku 6  
P. O. Box 57  
00681 Helsinki  
Phone +358 9 478411  
Fax +358 9 47841311
- GB United Kingdom**  
Weidmüller Ltd.  
1 Abbey Wood Road  
Kings Hill  
West Malling  
Kent ME19 4YT  
Phone +44 1732 877032  
Fax +44 1732 873873  
info@weidmuller.co.uk  
www.weidmuller.com
- GCA Guatemala**  
Please contact  
ELVATRON S. A., Costa Rica
- GR Greece**  
Electrorama S.A.  
1 An. Martali Str.  
41335 Larissa  
Phone +30 2410 552533  
Fax +30 2410 283463  
valvizos@electrorama.com.gr
- H Hungary**  
Weidmüller Kereskedelmi Kft  
Dombóvári út 13  
1117 Budapest  
P. O. Box 22  
1507 Budapest  
Phone +36 1 464-7888  
Fax +36 1 3827701  
info@weidmueller.hu
- HK Hong Kong**  
United Equity Limited  
Suite B, 11/F International Industrial  
Centre  
2-8 Kwei Tei Street, Fotan  
Shatin, N. T.  
Phone +852 26876739  
Fax +852 26876735
- HKJ Jordan**  
Please contact  
Weidmüller Middle East  
United Arab Emirates
- HO Honduras**  
Please contact  
ELVATRON S. A., Costa Rica
- HR Croatia**  
Elektro Partner d.o.o.  
Radnicka cesta 22  
10000 Zagreb  
Phone +385 1 6184793  
Fax +385 1 6184795  
elektropartner@zg.htnet.hr
- I Italy**  
Weidmüller S.r.l.  
Via Albert Einstein 4  
20092 Cinisello Balsamo  
Milano  
Phone +39 02 660681  
Fax +39 02 6124945  
weidmuller@weidmuller.it  
www.weidmuller.it
- IL Israel**  
A.U. Shay Ltd.  
Embar Street 23/25  
P.O.Box 10049  
Petach-Tikva 49222  
Phone +972 3 9233601  
Fax +972 3 9234601  
shay@uriel-shay.com
- IND India**  
Weidmüller Representative office  
Vijay Dattani  
119, Prashanth Extention  
Whitefield  
Bangalore - 560 066  
Phone +91 80 8453999  
Fax +91 80 8453999
- IR Iran**  
TAF Co.  
72, Iranshahr Av.  
Unit 5,  
15816 Teheran  
Phone +98 21 831-7851  
Fax +98 21 882-0268  
tafco@safinah.net
- IRL Ireland**  
A.P. Haslam Ltd.  
14 Sunshine Ind. Estate  
Crumlin Road  
Dublin 12  
Phone +353 1 453-2522  
Fax +353 1 453-2949  
paul.haslam@aphaslam.ie
- IS Iceland**  
Samey Automation Center  
Lyngas 13, 210 Garoabaer,  
Island  
Phone +354 510 5200  
Fax +354 510 5201  
samey@samey.is
- J Japan**  
Nihon Weidmüller Co. Ltd.  
Asahi Seimei Bldg. 11F  
1-14-1 Fuchicho Fuchu-shi  
Tokyo 183-0055 Japan  
Phone +81 42 330-7891  
Fax +81 42 330-7895  
www.weidmuller.co.jp
- KWT Kuwait**  
NOURI Industrial Establishment Co.  
P.O.Box 2829,  
Safat 13029 Kuwait  
Phone +965 4333355  
Fax +965 4344085  
contact@nie-kwt.com
- L Luxembourg**  
Please contact  
Weidmüller Belgium, Heverlee
- LT Lithuania**  
ELEKTROS IRANGA  
Tinklų g.29a, 5319 Panevezys,  
Lithuania  
Phone +370 45582828  
Fax +370 45582727  
info@eiranga.lt
- LV Latvia**  
Elektrosistemas  
Kuldigas St. 51,  
1046 Riga, Latvia  
Phone +371 7070140  
Fax +371 7070141  
edgars.vilkins@elektrosistemas.lv
- MA Morocco**  
Energy-Technics Transfer, S.A.  
23 Boulevard Lieutenant  
Mohamed El Bakai Tamri  
Casablanca 20250  
Phone +212 2 343700  
Fax +212 2 343699
- MAL Malaysia**  
Please contact  
Weidmüller Singapore
- MEX Mexico**  
W Interconnections, S.A. de C.V.  
Av. Ingenieros Civiles No. 204-B,  
Conjunto Industrial Chachapa  
72990 Chachapa,  
Puebla Mexico  
Phone +52 222 2866247/48/49  
Fax +52 222 2866242  
clientes@weidmuller.com.mx



- MK Macedonia**  
ES MK Elektrosistem d.o.o.  
Ul. Bulevar III makedonske brigade bb  
91000 Skoplje  
Macedonia  
Phone +389 91 460295  
Fax +389 91 460298  
elektrosistem-mk@mt.net.mk
- N Norway**  
Siv. Ing. J. F. Knudtzen A/S  
Billingstadsletta 97  
1396 Billingstad  
P.O. Box 160  
1378 Nesbru  
Phone +47 66 983350  
Fax +47 66 980955  
patorgersbraaten@jfknudtzen.no
- NIC Nicaragua**  
Please contact  
ELVATRON S. A., Costa Rica
- NL Netherlands**  
Weidmüller Benelux B.V.  
Franciscusweg 221  
1216 SE Hilversum  
Postbus 1505  
1200 BM Hilversum  
Phone +31 35 6261261  
Fax +31 35 6234569  
info@weidmuller.nl  
www.weidmuller.nl
- NZ New Zealand**  
Cuthbert S. Steward Limited  
27 Te Puni Street  
POB 38496 Petone  
Petone, Wellington  
Phone +64 4 5686156  
Fax +64 4 5686056
- OM Oman**  
Please contact  
Weidmüller Middle East  
United Arab Emirates
- P Portugal**  
Weidmüller - Sistemas de Interface, S. A.  
Estrada Outeiro Polima, Lote B,  
N° B2, Escritório 2 - Abóboda  
2785-518 Sao Domingos de Rana  
Lisboa  
Phone +351 21 4459190  
Fax +351 21 4455871  
weidmuller@weidmuller.pt  
www.weidmuller.pt
- PA Panama**  
Please contact  
ELVATRON S. A., Costa Rica
- PE Peru**  
DIN AUTOMATIZACION S. A.  
Rimac Pampa 385 - Maranga  
Lima 32  
Phone +51 1 4511733  
Fax +51 1 4491095  
mail@dinaut.com
- PK Pakistan**  
Access Technology Networks  
[Pvt] Ltd.  
Flat 1, 2nd Floor, Panther Plaza  
16B, F8, MARKAZ  
Islamabad  
Pakistan  
Phone +92 51 2254371-72  
Fax +92 51 2261086  
atn@isb.comsats.net.pk
- PL Poland**  
Weidmüller Sp. z o.o.  
ul. Goleđzinowska 10  
03-302 Warszawa  
Poland  
Phone +48 22 5100940  
Fax +48 22 5100941  
biuro@weidmuller.com.pl  
www.weidmuller.pl
- PY Paraguay**  
Rewo Paraguay S.A.  
Sucre 2590 esq Emeterio Miranda  
Asunción  
Paraguay  
Phone +595 21 60 60 13  
Fax +595 21 60 60 13  
rewo@telesurf.com.py
- Q Qatar**  
Please contact  
Weidmüller Middle East  
United Arab Emirates
- RA Argentina**  
CPI SA  
Bauness 2660  
1431 Buenos Aires  
Phone +54 11 45238008  
Fax +54 11 45220546  
compras@cpi.com.ar
- RC Taiwan**  
Fittatek Corp., Ltd.  
12 F No. 185 Fu-Kuo Rd,  
Tso Ying Dist,  
Kaohsiung, Taiwan R.O.C.  
Phone +886 7556-0858  
Fax +886 7556-3279
- RCH Chile**  
Felipe Bahamondes S.A./ATS AGRO  
Servicios Agroindustriales  
Maria Luisa Santander 0475  
Providencia  
Casilla 3425  
Santiago  
Phone +56 2 341-1271  
Fax +56 2 341-1275  
felipe@mailblocks.com
- RI Indonesia**  
P. T. Nego Electrindo  
Komplek Perkantoran Kramat Centre  
Blok-A 18 Jl Kramat Raya No. 7-9  
Jakarta 10450  
Phone +62 21 3156218  
Fax +62 21 3156219
- RL Libanon**  
Progress Engineering & Trading  
Enterprises  
P.O. Box 11-1111  
Pharaon Bldg., Opp Electr. du Liban  
Chafaca Str., Al Nahr  
Beirut - Libanon  
Phone +961 144 4664  
Fax +961 144 4664  
progress@inco.com.lb
- RO Romania**  
ROMINTERFACE IMPEX SRL  
Splaiul Unirii nr. 45, Bl. M 15  
sc. 3, ap. 68-69, Sect. 3  
74342 Bucuresti  
Phone +40 1 3220230  
Fax +40 1 3228857  
romint@dnt.ro
- ROK South Korea**  
Weidmüller Co., Ltd.  
2 floor Wooam B/D 46-27  
Samsung2-Dong, Kangnam-Ku  
Seoul  
Korea, Zip: 135-868  
Phone +82 2 5160003  
Fax +82 2 5160090  
info@weidmuller.co.kr
- RP Philippines**  
Tradepoints, Inc.  
3rd Floor PM Santiago Bldg.  
5081 P. Burgos Cor.,  
San Mateo Streets  
Makati Manila  
Phone +63 2 8993294  
Fax +63 2 8993306
- RUS Russia**  
Weidmüller Representative office  
Shabolovka street 2  
119049 Russia, Moskau  
Phone +7 095 771-6940  
Fax +7 095 771-6941  
info@weidmueller.ru  
www.weidmueller.ru
- S Sweden**  
Weidmüller AB  
Stockholm, Arenavägen 39,  
12177 Johanneshov  
P.O. Box 10120  
12128 Stockholm-Globen  
Phone +46 771 43 00 44  
Fax +46 8 7272480  
mail.stockholm@weidmuller.se
- SA Saudi Arabia**  
Al Abdulkarim Trading  
P.O. Box 5777, Dammam  
31432 Saudi Arabia  
Phone +966 3 833-7110  
Fax +966 3 833-8242  
info@akte.com.sa
- SA Saudi Arabia**  
Saudi Electric Supply Co.  
P.O. Box 3298, Al Khobar  
31952 Saudi Arabia  
Phone +966 3 882-9546227  
Fax +966 3 882-9547  
customer.service@sesco-ge.com
- SGP Singapore**  
Weidmüller Pte. Ltd.  
Cititech Building  
629 Aljunied Road #05-05  
Singapore 389838  
Phone +65 6841 5311  
Fax +65 6841 5377  
sales@weidmuller.com.sg  
www.weidmuller.com.sg
- SK Slovakia**  
Elektris s.r.o.  
Racianska 188  
SK 83153 Bratislava, Slovakia  
Phone +421 2 4920013  
Fax +421 2 44680328  
weidmueller@computel.sk
- SLO Slovenia**  
ELEKTROSPOLJ d.o.o.  
Stegne 25  
1000 Ljubljana  
Phone +38 6 15113810  
Fax +38 6 15111604  
elektrospolj@siol.net
- SYR Syria**  
Please contact  
Weidmüller Middle East,  
United Arab Emirates
- T Thailand**  
Pisanu Engineering &  
Construction Co. Ltd.  
800/2 Asoke-Dindaeng  
Road Dindaeng  
Bangkok 10400  
Phone +66 2 2459113  
Fax +66 2 2463214  
pisanu@kanit.co.th
- TR Turkey**  
Weidmüller Elektronik Ticaret Ltd.  
Sirketi  
Kore Sehilleri Cad. 34/1-7  
80300 Zincirlikuyu – Istanbul  
Phone +90 212 2730830  
Fax +90 212 2740874  
info@weidmuller.com.tr
- UA Ukraine**  
TEKO Interface  
Per.Industrialny 2  
03056 - Kiev  
Phone +380 04463 57760  
Fax +380 04463 91082  
elektro@panko.kiev.ua
- UAE U.A.E. United Arab Emirates**  
Weidmüller Middle-East  
P.O. Box 62448  
Dubai  
Phone +971 4 3522215, 3523043  
Fax +971 4 3599950
- USA USA**  
W-Interconnections, Inc.  
821 Southlake Boulevard,  
Richmond, VA 23236  
Phone +1 804 7942877  
Fax +1 804 3792593  
info@weidmuller.com  
www.weidmuller.com
- VN Vietnam**  
Thien Nghi Trading Pte  
60B Tan Da Street  
District 5 Ho Chi Min  
Phone +84 8 8555387  
Fax +84 8 8549304
- YU Serbia and Montenegro**  
ES YU Elektrosistem d.o.o.  
ul. Pariske komunne 41  
11070 Novi Beograd  
Serbia  
Phone +381 11 697212, 693608  
Fax +381 11 697212, 693608  
esyu@infosky.net  
www.elektrosistem.co.yu
- Y Venezuela**  
Somerinca C. A.  
Edificio Esteban Piso 2  
Calle Vargas Bolleita Notre  
Caracas 1070 A  
Venezuela  
Phone +58 212 2352748  
Fax +58 212 2385625  
hcastrog@somerincayv.com
- ZA South Africa**  
RAD Interface Pty. Ltd.  
5 Bundo Road  
Sebenza Extension  
Edenvale 1609  
P.O.Box 193  
Edenvale 1610  
Phone +27 11 452-1930  
Fax +27 11 452-6455  
alockyer@radinterface.co.za

**A** Group companies

**A** Agency abroad

**A** Without own Agency

We cannot guarantee that there are no mistakes in the publications or software provided by us to the customer for the purpose of making orders.

We try our best to correct any fault as soon as it is located. For this purpose we make all corrections, which have been made after publishing a catalogue, available on our website at [www.weidmueller.com](http://www.weidmueller.com). For your convenience we list order no. and catalogue page along.

This Internet-database is part of our catalogue.

All orders are based on our general terms of delivery, which can be reviewed on the websites of our group companies where you placed your order. On demand we can also send the general terms of delivery to you.



# www.weidmuller.com

Argentina	Indonesia	Saudi Arabia
Australia	Iran	Serbia/ Montenegro
Austria	Ireland	Singapore
Bahrain	Israel	Slovakia
Belarus	Italy	Slovenia
Belgium	Japan	South Africa
Bosnia- Herzegovina	Jordan	South Korea
Brazil	Kuwait	Spain
Bulgaria	Latvia	Sweden
Canada	Lebanon	Switzerland
Chile	Lithuania	Syria
China	Luxembourg	Taiwan
Colombia	Macedonia	Taiwan
Costa Rica	Malaysia	Thailand
Croatia	Morocco	Turkey
Czech Republic	Mexico	Ukraine
Denmark	Netherlands	United Arab Emirates
Egypt	New Zealand	United Kingdom
El Salvador	Nicaragua	USA
Estonia	Norway	Venezuela
Finland	Oman	Vietnam
France	Pakistan	Yemen
Germany	Panama	
Greece	Paraguay	
Guatemala	Peru	
Honduras	Philippines	
Hong Kong	Poland	
Hungary	Portugal	
Iceland	Qatar	
India	Romania	
	Russia	

**Weidmüller is the leading manufacturer of components for electrical connection technology. The Weidmüller product portfolio ranges from terminal blocks, PCB connectors and terminals, protected components and relay sockets to power supply and overvoltage protection modules suitable for all applications. Electrical installation and marking material, basic I/O components and a variety of tools round off the range. As an OEM supplier, the company sets global standards in the field of electrical connection technology.**

Order number:  
5649270000/03/2005/DMMD

